

# Remote Monitor & Monitor-In-Room Boom Options Installation

OPERATING DOCUMENTATION



5620471-1EN  
Revision 5  
©2020 GE Company  
All rights reserved.



# **LEGAL NOTES**

---

## **TRADEMARKS**

Adobe, the Adobe logo, Acrobat, the Acrobat logo, Exchange, and PostScript are trademarks of Adobe Systems Incorporated or its subsidiaries and may be registered in certain jurisdictions.

Microsoft is a registered trademark and Windows is a trademark of Microsoft Corporation.

All other products and their name brands are trademarks of their respective holders.

## **COPYRIGHTS**

All Material, Copyright © 2020 by GE Company, Inc. All rights reserved.

*This page intentionally left blank.*

# IMPORTANT PRECAUTIONS

## LANGUAGE

|                                       |  |
|---------------------------------------|--|
| <p><b>Предупреждение</b><br/>(BG)</p> | <ul style="list-style-type: none"> <li>• ТОВА УПЪТВАНЕ ЗА РАБОТА Е НАЛИЧНО САМО НА АНГЛИЙСКИ ЕЗИК.</li> <li>• АКО ДОСТАВЧИКЪТ НА УСЛУГАТА НА КЛИЕНТА ИЗИСКА ЕЗИК, РАЗЛИЧЕН ОТ АНГЛИЙСКИ, ЗАДЪЛЖЕНИЕ НА КЛИЕНТА Е ДА ОСИГУРИ ПРЕВОД.</li> <li>• НЕ ИЗПОЛЗВАЙТЕ ОБОРУДВАНЕТО ПРЕДИ ДА СТЕ СЕ КОНСУЛТИРАЛИ И РАЗБРАЛИ УПЪТВАНЕТО ЗА РАБОТА.</li> <li>• НЕСПАЗВАНЕТО НА ТОВА ПРЕДУПРЕЖДЕНИЕ МОЖЕ ДА ДОВЕДЕ ДО НАРАНЯВАНЕ НА ДОСТАВЧИКА НА УСЛУГАТА, ОПЕРАТОРА ИЛИ ПАЦИЕНТ В РЕЗУЛТАТ НА ТОКОВ УДАР ИЛИ МЕХАНИЧНА ИЛИ ДРУГА ОПАСНОСТ.</li> </ul>  |
| <p><b>警告</b><br/>(ZH-CN)</p>          | <ul style="list-style-type: none"> <li>• 本维修手册仅提供英文版本。</li> <li>• 如果维修服务提供商需要非英文版本，客户需自行提供翻译服务。</li> <li>• 未详细阅读和完全理解本维修手册之前，不得进行维修。</li> <li>• 忽略本警告可能对维修人员，操作员或患者造成触电、机械伤害或其他形式的伤害。</li> </ul>   |
| <p><b>警告</b><br/>(ZH-HK)</p>          | <p>本服務手冊僅提供英文版本。</p> <ul style="list-style-type: none"> <li>• 倘若客戶的服務供應商需要英文以外之服務手冊，客戶有責任提供翻譯服務。</li> <li>• 除非已參閱本服務手冊及明白其內容，否則切勿嘗試維修設備。</li> <li>• 不遵從本警告或會令服務供應商、網絡供應商或病人受到觸電、機械性或其他危險。</li> </ul>   |
| <p><b>警告</b><br/>(ZH-TW)</p>          | <p>本維修手冊僅有英文版。</p> <ul style="list-style-type: none"> <li>• 若客戶的維修廠商需要英文版以外的語言，應由客戶自行提供翻譯服務。</li> <li>• 請勿試圖維修本設備，除非您已查閱並瞭解本維修手冊。</li> <li>• 若未留意本警告，可能導致維修廠商、操作員或病患因觸電、機械或其他危險而受傷。</li> </ul>   |
| <p><b>UPOZORENJE</b><br/>(HR)</p>     | <p>Ovaj servisni priručnik dostupan je na engleskom jeziku.</p> <ul style="list-style-type: none"> <li>• Ako davatelj usluge klijenta treba neki drugi jezik, klijent je dužan osigurati prijevod.</li> <li>• Ne pokušavajte servisirati opremu ako niste u potpunosti pročitali i razumjeli ovaj servisni priručnik.</li> <li>• Zanimajte li ovo upozorenje, može doći do ozljede davatelja usluge, operatera ili pacijenta uslijed strujnog udara, mehaničkih ili drugih rizika.</li> </ul>  |
| <p><b>VÝSTRAHA</b><br/>(CS)</p>       | <ul style="list-style-type: none"> <li>• Tento provozní návod existuje pouze v anglickém jazyce.</li> <li>• V případě, že externí služba zákazníkům potřebuje návod v jiném jazyce, je zajištění překladu do odpovídajícího jazyka úkolem zákazníka.</li> <li>• Nesnažte se o údržbu tohoto zařízení, aniž byste si přečetli tento provozní návod a pochopili jeho obsah.</li> <li>• V případě nedodržování této výstrahy může dojít k poranění pracovníka prodejního servisu, obslužného personálu nebo pacientů vlivem elektrického proudu, respektive vlivem mechanických či jiných rizik.</li> </ul> |

|                                     |  |
|-------------------------------------|--|
| <p><b>ADVARSEL</b><br/>(DA)</p>     | <ul style="list-style-type: none"> <li>• Denne servicemanual findes kun på engelsk.</li> <li>• Hvis en kundes tekniker har brug for et andet sprog end engelsk, er det kundens ansvar at sørge for oversættelse.</li> <li>• Forsøg ikke at servicere udstyret medmindre denne servicemanual har været konsulteret og er forstået.</li> <li>• Manglende overholdelse af denne advarsel kan medføre skade på grund af elektrisk, mekanisk eller anden fare for teknikeren, operatøren eller patienten.</li> </ul>  |
| <p><b>WAARSCHUWING</b><br/>(NL)</p> | <ul style="list-style-type: none"> <li>• Deze onderhoudshandleiding is enkel in het Engels verkrijgbaar.</li> <li>• Als het onderhoudspersoneel een andere taal vereist, dan is de klant verantwoordelijk voor de vertaling ervan.</li> <li>• Probeer de apparatuur niet te onderhouden voordat deze onderhoudshandleiding werd geraadpleegd en begrepen is.</li> <li>• Indien deze waarschuwing niet wordt opgevolgd, zou het onderhoudspersoneel, de operator of een patiënt gewond kunnen raken als gevolg van een elektrische schok, mechanische of andere gevaren.</li> </ul> |
| <p><b>WARNING</b><br/>(EN)</p>      | <ul style="list-style-type: none"> <li>• This Service Manual is available in English only.</li> <li>• If a customer's service provider requires a language other than English, it is the customer's responsibility to provide translation services.</li> <li>• Do not attempt to service the equipment unless this service manual has been consulted and is understood.</li> <li>• Failure to heed this warning may result in injury to the service provider, operator, or patient, from electric shock or from mechanical or other hazards.</li> </ul>                            |
| <p><b>HOIATUS</b><br/>(ET)</p>      | <ul style="list-style-type: none"> <li>• Käesolev teenindusjuhend on saadaval ainult inglise keeles.</li> <li>• Kui klienditeeninduse osutaja nõuab juhendit inglise keelest erinevas keeles, vastutab klient tõlketeenuse osutamise eest.</li> <li>• Ärge üritage seadmeid teenindada enne eelnevalt käesoleva teenindusjuhendiga tutvumist ja sellest aru saamist.</li> <li>• Käesoleva hoiatuse eiramine võib põhjustada teenuseosutaja, operaatori või patsiendi vigastamist elektrilöögi, mehaanilise või muu ohu tagajärjel.</li> </ul>                                      |
| <p><b>VAROITUS</b><br/>(FI)</p>     | <ul style="list-style-type: none"> <li>• Tämä huolto-ohje on saatavilla vain englanniksi.</li> <li>• Jos asiakkaan huoltohenkilöstö vaatii muuta kuin englanninkielistä materiaalia, tarvittavan käännöksen hankkiminen on asiakkaan vastuulla.</li> <li>• Älä yritä korjata laitteistoa ennen kuin olet varmasti lukenut ja ymmärtänyt tämän huolto-ohjeen.</li> <li>• Mikäli tätä varoitusta ei noudateta, seurauksena voi olla huoltohenkilöstön, laitteiston käyttäjän tai potilaan vahingoittuminen sähköiskun, mekaanisen vian tai muun vaaratilanteen vuoksi.</li> </ul>    |
| <p><b>ATTENTION</b><br/>(FR)</p>    | <ul style="list-style-type: none"> <li>• Ce manuel de service n'est disponible qu'en anglais.</li> <li>• Si le technicien du client a besoin de ce manuel dans une autre langue que l'anglais, c'est au client qu'il incombe de le faire traduire.</li> <li>• Ne pas tenter d'intervenir sur les équipements tant que le manuel service n'a pas été consulté et compris.</li> <li>• Le non-respect de cet avertissement peut entraîner chez le technicien, l'opérateur ou le patient des blessures dues à des dangers électriques, mécaniques ou autres.</li> </ul>                |

|                                       |   |
|---------------------------------------|---|
| <p><b>WARNUNG</b><br/>(DE)</p>        | <ul style="list-style-type: none"> <li>• Diese Serviceanleitung existiert nur in Englischer Sprache.</li> <li>• Falls ein fremder Kundendienst eine andere Sprache benötigt, ist es Aufgabe des Kunden für eine entsprechende Übersetzung zu sorgen.</li> <li>• Versuchen Sie nicht diese Anlage zu warten, ohne diese Serviceanleitung gelesen und verstanden zu haben.</li> <li>• Wird diese Warnung nicht beachtet, so kann es zu Verletzungen des Kundendiensttechnikers, des Bedieners, oder des Patienten durch Stromschläge, oder mechanische und sonstige Gefahren kommen.</li> </ul>   |
| <p><b>ΠΡΟΕΙΔΟΠΟΙΗΣΗ</b><br/>(EL)</p>  | <ul style="list-style-type: none"> <li>• Το παρόν εγχειρίδιο σέρβις διατίθεται στα αγγλικά μόνο.</li> <li>• Εάν το άτομο παροχής σέρβις ενός πελάτη απαιτεί το παρόν εγχειρίδιο σε γλώσσα εκτός των αγγλικών, αποτελεί ευθύνη του πελάτη να παρέχει υπηρεσίες μετάφρασης.</li> <li>• Μην επιχειρήσετε την εκτέλεση εργασιών σέρβις στον εξοπλισμό εκτός εάν έχετε συμβουλευτεί και έχετε κατανοήσει το παρόν εγχειρίδιο σέρβις.</li> <li>• Εάν δε λάβετε υπόψη την προειδοποίηση αυτή, ενδέχεται να προκληθεί τραυματισμός στο άτομο παροχής σέρβις, στο χειριστή ή στον ασθενή από ηλεκτροπληξία, μηχανικούς ή άλλους κινδύνους.</li> </ul>                              |
| <p><b>FIGYELMEZTETÉS</b><br/>(HU)</p> | <ul style="list-style-type: none"> <li>• Ezen karbantartási kézikönyv kizárólag angol nyelven érhető el.</li> <li>• Ha a vevő szolgáltatója angoltól eltérő nyelvre tart igényt, akkor a vevő felelőssége a fordítás elkészítése.</li> <li>• Ne próbálja elkezdni használni a berendezést, amíg a karbantartási kézikönyvben leírtakat nem értelmezték.</li> <li>• Ezen figyelmeztetés figyelmen kívül hagyása a szolgáltató, működtető vagy a beteg áramütés, mechanikai vagy egyéb veszélyhelyzet miatti sérülését eredményezheti.</li> </ul>   |
| <p><b>AÐVÖRUN</b><br/>(IS)</p>        | <ul style="list-style-type: none"> <li>• Þessi þjónustuhandbók er eingöngu fáanleg á ensku.</li> <li>• Ef að þjónustuveitandi viðskiptamanns þarfnast annas tungumáls en ensku, er það skylda viðskiptamanns að skaffa tungumálþjónustu.</li> <li>• Reynið ekki að afgreiða tækið nema að þessi þjónustuhandbók hefur verið skoðuð og skilin.</li> <li>• Brot á sinna þessari aðvörun getur leitt til meiðsla á þjónustuveitanda, stjórnanda eða sjúklings frá raflosti, vélrænu eða öðrum áhættum.</li> </ul>  |
| <p><b>AVVERTENZA</b><br/>(IT)</p>     | <ul style="list-style-type: none"> <li>• Il presente manuale di manutenzione è disponibile soltanto in inglese.</li> <li>• Se un addetto alla manutenzione richiede il manuale in una lingua diversa, il cliente è tenuto a provvedere direttamente alla traduzione.</li> <li>• Si proceda alla manutenzione dell'apparecchiatura solo dopo aver consultato il presente manuale ed averne compreso il contenuto.</li> <li>• Il non rispetto della presente avvertenza potrebbe far compiere operazioni da cui derivino lesioni all'addetto, alla manutenzione, all'utilizzatore ed al paziente per folgorazione elettrica, per urti meccanici od altri rischi.</li> </ul> |
| <p><b>警告</b><br/>(JA)</p>             | <ul style="list-style-type: none"> <li>• このサービスマニュアルには英語版しかありません。</li> <li>• サービスを担当される業者が英語以外の言語を要求される場合、翻訳作業はその業者の責任で行うものとさせていただきます。</li> <li>• このサービスマニュアルを熟読し理解せずに、装置のサービスを行わないでください。</li> <li>• この警告に従わない場合、サービスを担当される方、操作員あるいは患者さんが、感電や機械的又はその他の危険により負傷する可能性があります。</li> </ul>   |

|                                    |   |
|------------------------------------|---|
| <p><b>경고</b><br/>(KO)</p>          | <ul style="list-style-type: none"> <li>• 본 서비스 지침서는 영어로만 이용하실 수 있습니다.</li> <li>• 고객의 서비스 제공자가 영어 이외의 언어를 요구할 경우, 번역 서비스를 제공하는 것은 고객의 책임입니다.</li> <li>• 본 서비스 지침서를 참고했고 이해하지 않는 한은 해당 장비를 수리하려고 시도하지 마십시오.</li> <li>• 이 경고에 유의하지 않으면 전기 쇼크, 기계상의 혹은 다른 위험으로부터 서비스 제공자, 운영자 혹은 환자에게 피해를 가할 수 있습니다.</li> </ul>   |
| <p><b>BRDINJUMS</b><br/>(LV)</p>   | <ul style="list-style-type: none"> <li>• Šī apkalpes rokasgrāmata ir pieejama tikai angļu valodā.</li> <li>• Ja klienta apkalpes sniedzējam nepieciešama informācija citā valodā, nevis angļu, klienta pienākums ir nodrošināt tulkošanu.</li> <li>• Neveiciet aprīkojuma apkalpi bez apkalpes rokasgrāmatas izlasīšanas un saprašanas.</li> <li>• Šī brīdinājuma neievērošana var radīt elektriskās strāvas trieciena, mehānisku vai citu risku izraisītu traumu apkalpes sniedzējam, operatoram vai pacientam.</li> </ul>   |
| <p><b>ĮSPĖJIMAS</b><br/>(LT)</p>   | <ul style="list-style-type: none"> <li>• Šis eksploataavimo vadovas yra prieinamas tik anglų kalba.</li> <li>• Jei kliento paslaugų tiekėjas reikalauja vadovo kita kalba – ne anglų, numatyti vertimo paslaugas yra kliento atsakomybė.</li> <li>• Nemėginkite atlikti įrangos techninės priežiūros, nebent atsižvelgėte į šį eksploataavimo vadovą ir jį supratote.</li> <li>• Jei neatkreipsite dėmesio į šį perspėjimą, galimi sužalojimai dėl elektros šoko, mechaninių ar kitų pavojų paslaugų tiekėjui, operatoriui ar pacientui.</li> </ul>   |
| <p><b>ADVARSEL</b><br/>(NO)</p>    | <ul style="list-style-type: none"> <li>• Denne servicehåndboken finnes bare på engelsk.</li> <li>• Hvis kundens serviceleverandør trenger et annet språk, er det kundens ansvar å sørge for oversettelse.</li> <li>• Ikke forsøk å reparere utstyret uten at denne servicehåndboken er lest og forstått.</li> <li>• Manglende hensyn til denne advarselen kan føre til at serviceleverandøren, operatøren eller pasienten skades på grunn av elektrisk støt, mekaniske eller andre farer.</li> </ul>  |
| <p><b>OSTRZEŻENIE</b><br/>(PL)</p> | <ul style="list-style-type: none"> <li>• Niniejszy podręcznik serwisowy dostępny jest jedynie w języku angielskim.</li> <li>• Jeśli dostawca usług klienta wymaga języka innego niż angielski, zapewnienie usługi tłumaczenia jest obowiązkiem klienta.</li> <li>• Nie próbować serwisować wyposażenia bez zapoznania się i zrozumienia niniejszego podręcznika serwisowego.</li> <li>• Niezastosowanie się do tego ostrzeżenia może spowodować urazy dostawcy usług, operatora lub pacjenta w wyniku porażenia elektrycznego, zagrożenia mechanicznego bądź innego.</li> </ul>               |
| <p><b>ATENÇÃO</b><br/>(PT-BR)</p>  | <ul style="list-style-type: none"> <li>• Este manual de assistência técnica só se encontra disponível em inglês.</li> <li>• Se qualquer outro serviço de assistência técnica, que não a gems, solicitar estes manuais noutro idioma, é da responsabilidade do cliente fornecer os serviços de tradução.</li> <li>• Não tente reparar o equipamento sem ter consultado e compreendido este manual de assistência técnica.</li> <li>• O não cumprimento deste aviso pode por em perigo a segurança do técnico, operador ou paciente devido a choques elétricos, mecânicos ou outros.</li> </ul> |

|                                    |  |
|------------------------------------|--|
| <p><b>ATENÇÃO</b><br/>(PT-PT)</p>  | <ul style="list-style-type: none"> <li>• Este manual de assistência técnica só se encontra disponível em inglês.</li> <li>• Se qualquer outro serviço de assistência técnica, que não a gems, solicitar estes manuais noutra idioma, é da responsabilidade do cliente fornecer os serviços de tradução.</li> <li>• Não tente reparar o equipamento sem ter consultado e compreendido este manual de assistência técnica.</li> <li>• O não cumprimento deste aviso pode colocar em perigo a segurança do técnico, do operador ou do paciente devido a choques eléctricos, mecânicos ou outros</li> </ul>  |
| <p><b>ATENȚIE</b><br/>(RO)</p>     | <ul style="list-style-type: none"> <li>• Acest manual de service este disponibil numai în limba engleză.</li> <li>• Dacă un furnizor de servicii pentru clienți necesită o altă limbă decât cea engleză, este de datoria clientului să furnizeze o traducere.</li> <li>• Nu încercați să reparați echipamentul decât ulterior consultării și înțelegerii acestui manual de service.</li> <li>• Ignorarea acestui avertisment ar putea duce la rănirea depanatorului, operatorului sau pacientului în urma pericolelor de electrocutare, mecanice sau de altă natură.</li> </ul>  |
| <p><b>ОСТОРОЖНО!</b><br/>(RU)</p>  | <ul style="list-style-type: none"> <li>• Данное руководство по обслуживанию предлагается только на английском языке.</li> <li>• Если сервисному персоналу клиента необходимо руководство не на английском, а на каком-то другом языке, клиенту следует самостоятельно обеспечить перевод.</li> <li>• Перед обслуживанием оборудования обязательно обратитесь к данному руководству и поймите изложенные в нем сведения.</li> <li>• Несоблюдение требований данного предупреждения может привести к тому, что специалист по обслуживанию, оператор или пациент получат удар электрическим током, механическую травму или другое повреждение.</li> </ul> |
| <p><b>UPOZORENJE</b><br/>(SR)</p>  | <ul style="list-style-type: none"> <li>• Ovo servisno uputstvo je dostupno samo na engleskom jeziku.</li> <li>• Ako klijentov serviser zahteva neki drugi jezik, klijent je dužan da obezbedi prevodilacke usluge.</li> <li>• Ne pokušavajte da opravite uredaj ako niste procitali i razumeli ovo servisno uputstvo.</li> <li>• Zanemarivanje ovog upozorenja može dovesti do povredivanja serviser, rukovaoca ili pacijenta usled strujnog udara ili mehanickih i drugih opasnosti.</li> </ul>   |
| <p><b>UPOZORNENIE</b><br/>(SK)</p> | <ul style="list-style-type: none"> <li>• Tento návod na obsluhu je k dispozícii len v angličtine.</li> <li>• Ak zákazníkovi poskytovateľ služieb vyžaduje iný jazyk ako angličtinu, poskytnutie prekladateľských služieb je zodpovednosťou zákazníka.</li> <li>• Nepokúšajte sa o obsluhu zariadenia skôr, ako si neprečítate návod na obsluhu a neporozumiete mu.</li> <li>• Zanedbanie tohto upozornenia môže vyústiť do zranenia poskytovateľa služieb, obsluhujúcej osoby alebo pacienta elektrickým prúdom, do mechanického alebo iného nebezpečenstva.</li> </ul>  |

|                                  |  |
|----------------------------------|--|
| <p><b>ATENCION</b><br/>(ES)</p>  | <ul style="list-style-type: none"> <li>• Este manual de servicio sólo existe en inglés.</li> <li>• Si el encargado de mantenimiento de un cliente necesita un idioma que no sea el inglés, el cliente deberá encargarse de la traducción del manual.</li> <li>• No se deberá dar servicio técnico al equipo, sin haber consultado y comprendido este manual de servicio.</li> <li>• La no observancia del presente aviso puede dar lugar a que el proveedor de servicios, el operador o el paciente sufran lesiones provocadas por causas eléctricas, mecánicas o de otra naturaleza.</li> </ul> |
| <p><b>VARNING</b><br/>(SV)</p>   | <ul style="list-style-type: none"> <li>• Den här servicehandboken finns bara tillgänglig på engelska.</li> <li>• Om en kunds servicetekniker har behov av ett annat språk än engelska ansvarar kunden för att tillhandahålla översättningstjänster.</li> <li>• Försök inte utföra service på utrustningen om du inte har läst och förstår den här servicehandboken.</li> <li>• Om du inte tar hänsyn till den här varningen kan det resultera i skador på serviceteknikern, operatören eller patienten till följd av elektriska stötar, mekaniska faror eller andra faror.</li> </ul>            |
| <p><b>OPOZORILO</b><br/>(SL)</p> | <p>Ta servisni priročnik je na voljo samo v angleškem jeziku.</p> <ul style="list-style-type: none"> <li>• Če ponudnik storitve stranke potrebuje priročnik v drugem jeziku, mora stranka zagotoviti prevod.</li> <li>• Ne poskušajte servisirati opreme, če tega priročnika niste v celoti prebrali in razumeli.</li> <li>• Če tega opozorila ne upoštevate, se lahko zaradi električnega udara, mehanskih ali drugih nevarnosti poškoduje ponudnik storitev, operater ali bolnik.</li> </ul>   |
| <p><b>DIKKAT</b><br/>(TR)</p>    | <ul style="list-style-type: none"> <li>• Bu servis kilavuzunun sadece ingilizcesi mevcuttur.</li> <li>• Eğer müşteri teknisyeni bu kilavuzu ingilizce dışında bir başka lisandan talep ederse, bunu tercüme ettirmek müşteriye düşer.</li> <li>• Servis kilavuzunu okuyup anlamadan ekipmanlara müdahale etmeyiniz.</li> <li>• Bu uyariya uyulmaması, elektrik, mekanik veya diğer tehlikelerden dolayı teknisyen, operatör veya hastanın yaralanmasına yol açabilir.</li> </ul>   |

## DAMAGE IN TRANSPORTATION

You should closely examine all packages at time of delivery. If you notice any damage, have the notation "Damage in Shipment" written on all copies of the freight or express bill before delivery is accepted or "signed for" by any General Electric representative or hospital receiving agent. Whether noted or concealed, you MUST report damage to the carrier immediately upon discovery and within 14 days after receipt, and you must hold the contents and containers for inspection by the carrier. A transportation company will not pay a claim for damage if you do not request an inspection within this 14-day period.

To file a report:

- Call 1-800-548-3366 and use option 6.
- Fill out the GIQ workflow for any items missing, damaged, OBF/FOI for in process installs: [http://supportcentral.ge.com/ProcessMaps/form\\_new\\_request.asp?prod\\_id=268679&form\\_id=573167&node\\_id=1916016&map\\_id=&reference\\_id=&reference\\_type](http://supportcentral.ge.com/ProcessMaps/form_new_request.asp?prod_id=268679&form_id=573167&node_id=1916016&map_id=&reference_id=&reference_type)
- Contact your local service coordinator for more information on this process.

## **CERTIFIED ELECTRICAL CONTRACTOR STATEMENT**

All electrical installations that are preliminary to positioning of the equipment at the site prepared for the equipment shall be performed by licensed electrical contractors. In addition, electrical feeds into the Power Distribution Unit shall be performed by licensed electrical contractors. Other connections between pieces of electrical equipment, calibrations and testing shall be performed by qualified GE Company personnel. The products involved (and the accompanying electrical installations) are highly sophisticated, and special engineering competence is required. In performing all electrical work on these products, GE will use its own specially trained field engineers. All of GE's electrical work on these products will comply with the requirements of the applicable electrical codes.

The purchaser of GE equipment shall only utilize qualified personnel (i.e., GE's field engineers, personnel of third-party service companies with equivalent training, or licensed electricians) to perform electrical servicing on the equipment.

## **IMPORTANT...X-RAY PROTECTION**

X-ray equipment, if not properly used, may cause injury. Accordingly, the instructions herein contained should be thoroughly read and understood by everyone who will use the equipment before you attempt to place this equipment in operation. The General Electric Company, GE Company, will gladly assist and cooperate in placing this equipment in use.

Although this apparatus incorporates a high degree of protection against x-radiation other than the useful beam, no practical design of equipment can provide complete protection. Nor can any practical design compel the operator to take adequate precautions to prevent the possibility of any persons carelessly exposing themselves or others to radiation.

It is important that anyone having anything to do with x-radiation be properly trained and fully acquainted with the recommendations of the National Council on Radiation Protection and Measurements as published in NCRP Reports available from NCRP Publications, 7910 Woodmont Avenue, Room 1016, Bethesda, Maryland 20814, and of the International Commission on Radiation Protection, and take adequate steps to protect against injury.

The equipment is sold with the understanding that the General Electric Company, GE Company, its agents, and representatives have no responsibility for injury or damage which may result from improper use of the equipment.

Various protective materials and devices are available. It is urged that such materials or devices be used.

## **OMISSIONS & ERRORS**

Customers: please contact the GE Company Sales or Service representatives. GE personnel: please use the GE Company iTrak/PQR Process to report all omissions, errors, and defects in this publication.

---

*This page intentionally left blank.*

# Revision History

| Revision | Date         | Reason for change  |
|----------|--------------|--|
| 5        | 27-May-2020  | <ul style="list-style-type: none"> <li>Update B7710AN BOM in Chapter 1.</li> <li>Add emulator setting in Chapter 2, Section 1 &amp; 7.</li> <li>Add Regulatory Requirement in Chapter 2, Section 5</li> <li>Update Figure 2-2 &amp; Figure 2-4</li> <li>Add Emulator related contents in Chapter 2, Section 10.</li> <li>Add note for DIN6868-157 LCD Monitor in Chapter 2, Section 11.</li> </ul> |
| 4        | 19-Aug-2019  | <ul style="list-style-type: none"> <li>Add Z8G4 console information.</li> <li>Restore Section 7.0 EDID Programming to original version.</li> </ul>   |
| 3        | 7-July-2017  | <ul style="list-style-type: none"> <li>Add Z840 console information.</li> <li>Update Section 7.0 EDID Programming for Splitter according to SCHDM00444248.</li> </ul>  |
| 2        | 20-July-2015 | <ul style="list-style-type: none"> <li>Update cable length to 21.6 m (71 ft.) and delete EIZO LCD monitor S1921-X (5169069-4) in Chapter 1, Section 4.0.</li> <li>Update Figure 1-1 Table and Gantry Top View.</li> <li>Add step for OC splitter installation in Chapter 2, Section 1.0.</li> <li>Update Figure 2-2 Junction Box Mounting Plate and Boom Mounting Plate.</li> </ul>                |
| 1        | 26-Mar-2015  | Initial release.   |

---

*This page intentionally left blank.*

# Table of Contents

---

## Chapter 1

|  |           |
|--|-----------|
| <b>Pre-Installation Information .....</b>                              | <b>17</b> |
| <b>Section 1.0</b>   |           |
| <b>Software .....</b>  | <b>17</b> |
| <b>Section 2.0</b>   |           |
| <b>Environmental Conditions.....</b>                                   | <b>17</b> |
| 2.1 Temperature and Humidity Specifications: Ambient Temperature ..... | 17        |
| 2.2 Electro-Magnetic Interference (EMI).....                           | 17        |
| 2.3 Seismic Data.....  | 17        |
| 2.4 Installation Changes .....   | 17        |
| 2.5 Installation Changes for Germany .....                             | 18        |
| <b>Section 3.0</b>   |           |
| <b>Catalog Numbers and Parts Lists.....</b>                            | <b>18</b> |
| 3.1 Catalog Numbers .....  | 18        |
| 3.2 Part Lists .....   | 18        |
| <b>Section 4.0</b>   |           |
| <b>Exam Suite Monitor with LCD Option.....</b>                         | <b>21</b> |
| 4.1 Site Preparation .....   | 21        |
| 4.2 Component Dimensions .....   | 21        |
| 4.3 Remote Monitor Power Requirements.....                             | 22        |

## Chapter 2

|   |           |
|---|-----------|
| <b>Boom Installation .....</b>                          | <b>23</b> |
| <b>Section 1.0</b>                                      |           |
| <b>Introduction .....</b>                               | <b>23</b> |
| <b>Section 2.0</b>                                      |           |
| <b>Required Tools .....</b>                             | <b>23</b> |
| <b>Section 3.0</b>                                      |           |
| <b>Personnel Requirements .....</b>                     | <b>23</b> |
| <b>Section 4.0</b>                                      |           |
| <b>Boom Installation Typical Layout.....</b>            | <b>24</b> |
| <b>Section 5.0</b>                                      |           |
| <b>Installation Requirement .....</b>                   | <b>25</b> |
| 5.1 Regulatory Requirement.....                         | 25        |
| 5.2 Junction Plate Requirement.....                     | 25        |
| <b>Section 6.0</b>                                      |           |
| <b>Installation Tips .....</b>                          | <b>28</b> |
| 6.1 Boom Pedestal Installation .....                    | 28        |
| 6.2 Boom Arm Assembly Installation.....                 | 31        |
| 6.3 Junction Box Cover Plate Assembly Installation..... | 33        |

---

|   |   |           |
|---|---|-----------|
| 6.4   | Arm Balancing Adjustment.....                     | 40        |
| <b>Section 7.0</b>  |   |           |
| <b>EDID Programming or Configuration.....</b>                       |   | <b>41</b> |
| 7.1   | EDID Programming for Splitter.....                | 41        |
| 7.2   | DVI EDID Emulator Setting.....                    | 41        |
| <b>Section 8.0</b>  |   |           |
| <b>Remote Monitor Installation .....</b>                            |   | <b>43</b> |
| 8.1   | Monitor Installation.....                         | 43        |
| 8.2   | Route and Connect Monitor Cables.....             | 44        |
| <b>Section 9.0</b>  |   |           |
| <b>Before You Begin.....</b>  |   | <b>46</b> |
| <b>Section 10.0</b>   |   |           |
| <b>Operator Console Connection.....</b>                             |   | <b>47</b> |
| 10.1  | NIO Console with Z820/Z840 Host Computer.....     | 47        |
| 10.2  | OpenOC Console with Z840/Z8G4 Host Computer ..... | 54        |
| 10.3  | StandAlone Console with Z8G4 Host Computer.....   | 61        |
| <b>Section 11.0</b>   |   |           |
| <b>Finalization .....</b>   |   | <b>65</b> |
| 11.1  | Restore System Power .....                        | 65        |
| 11.2  | Adjust Monitor Contrast/Brightness.....           | 65        |
| <b>Section 12.0</b>   |   |           |
| <b>Patient Touch Leakage Test and Ground Resistance Check .....</b> |   | <b>65</b> |

# Chapter 1

## Pre-Installation Information

### Section 1.0 Software

There are no special software requirements. The monitors function with all software versions.

### Section 2.0 Environmental Conditions

The following standard environmental condition requirements must be met. There are no changes unless otherwise noted.

#### 2.1 Temperature and Humidity Specifications: Ambient Temperature

Maintain a temperature of 70° – 75° F (21° – 24° C) in scan room for patient comfort. When scan room is unoccupied, table and gantry temperature limitations are 64° – 79° F (18° – 26° C).

#### 2.2 Electro-Magnetic Interference (EMI)

Color Monitor. Locate color monitors in ambient static magnetic fields of less than  $5 \times 10^{-5}$  tesla to guarantee color purity and display geometry.

If fields where excessive EMI is known or suspected to be present, consult GE Medical Systems for recommendations. Consider the following if you attempt to reduce EMI:

- External field strength decreases rapidly with distance from the source of the magnetic field.
- The external leakage magnetic field of a three-phase transformer is much less than that of a bank of three single phase transformers of equivalent power rating.
- Large electric motors are a source of substantial EMI.
- Steel reinforcing in building structure can be a conductor of EMI.
- High-powered radio signals are a source of EMI.
- Maintain good screening of cables and cabinets.

#### 2.3 Seismic Data

Follow the specified seismic reinforcement requirements for your area.

#### 2.4 Installation Changes

The NIO and Open requires that console options are powered from the Console AC Box.  
The Standalone requires that console options are powered from the Power Box.

The options are powered with IEC power connectors. If you have an existing Remote Monitor installed and you plan to use this unit with your new boom-in-room option, you will need to order B-CAT B7820HD.

## 2.5 Installation Changes for Germany

Customers can choose to purchase B75052CC if they use their CT system for the primary diagnostic image review by the radiologist. The option kit (B75052CC) provides a 19inch monitor solution complies to Germany DIN6868-157.

# Section 3.0

## Catalog Numbers and Parts Lists

### 3.1 Catalog Numbers

| CATALOG# | DESCRIPTION  |
|----------|--|
| B7820HD  | IEC Cable Adapter kit                                      |
| B75052CC | DIN6868-157 Monitor Option Kit, only available for Germany |
| B7710AN  | LCD & SUSP (Boom in Room) Linux                            |

Table 1-1 Catalog Numbers

### 3.2 Part Lists

| P/N       | QTY | DESCRIPTION  |
|-----------|-----|--|
| 5308429   | 0.1 | Brady PWC-PK-3, Write-On Self-Laminating Wire and Cable Markers    |
| 5315013-5 | 2.0 | Power Cable for Service  |
| 5323527   | 1.0 | Power Cable, Supply End - IEC-60320-C14 Equipment End - NEMA 5-15R |

Table 1-2 B7820HD Accessory Cable Collector (5323350 BOM)

| P/N            | QTY | DESCRIPTION  |
|----------------|-----|--|
| 5798612-1EN    | 1.0 | DIN Monitor Option Installation Manual   |
| 5797891        | 1.0 | Boom in Room DIN monitor spacer  |
| 5746368        | 1.0 | 19 inches LCD HB color monitor w stand - DICOM preset  |
| 1000-M4C020-04 | 4.0 | Hexagon Socket Head Cap Screw, M4-0.7, X20mm Long, Grade 8.8 Steel, Zinc Plated, RoHS Fastener |
| 2203-M4-07     | 4.0 | Curved Lock Washer, DIN 128A, M4, Spring Steel, Zinc Plated, RoHS Fastener                     |
| 2000-M4-02     | 4.0 | Flat Washer, ISO7089, M4, Steel 140HV, Zinc Plated, RoHS Fastener                              |

Table 1-3 B75052CC DIN6868-157 LCD Monitor Option Kit (5798612 BOM)

| P/N             | QTY | DESCRIPTION  |
|-----------------|-----|--|
| 46-302200P10    | 1   | 1.72 X 1.10, MODEL#, SN, DATE, DESC.   |
| 5160969-3       | 1   | Complete Suspension containing ceiling column 5160969 and suspension arm 5160969-2               |
| 5169069-8       | 1   | CT Use Eizo 19inch LCD Monitor FlexScan S1923-gray   |
| 5161129         | 1   | LCD Bracket Short Arm  |
| 2212717         | 1   | CABLE COVER FOR LCD SUSPENSION 3.6   |
| 5116219         | 1   | Grounding Cable For LCD Console To LCD   |
| 2213219         | 1   | POWER CABLE FOR LCD-CONSOLE TO LCD   |
| 5620471-1EN     | 1   | Monitor In-Room Boom Options Installation  |
| 2265406-2       | 1   | FIBER-OPTIC COUPLING RECEPTACLE KIT, 2.5MM BAYONET, AMP OPTIMATE--RoHS                           |
| 5573892         | 1   | Ceiling plate assembly, Tang   |
| 5573887         | 1   | Ceiling plate box, Tang  |
| 1000-M6C016-04  | 5   | Hexagon Socket Head Cap Screw, M6-1, X16mm Long, Grade 8.8 Steel, Zinc Plated, RoHS Fastener     |
| 1000-M12C035-04 |     | Hexagon Socket Head Cap Screw, M12-1.75, X35mm Long, Grade 8.8 Steel, Zinc Plated, RoHS Fastener |
| 2204-M12-06     | 2   | External Toothed Lock Washer, DIN 6797A, M12, Spring Steel, Zinc Plated, RoHS Fastener           |
| 5582184         | 1   | Digital Video Splitter kit   |
| 5573682         | 1   | Vedo AMP DVDF200   |
| 5573687         | 1   | ACDC power model for DVDF200   |
| 5573672         | 1   | cable fiber optic, from Vedo AMP output to AC BOX fiber connector inside                         |
| 5573673         | 1   | cable fiber optic, from AC BOX outside to Vedo receiver  |
| 5573685         | 1   | Vedo Receiver DVFX100  |
| 5573769         | 1   | ACDC power model for DVFX100   |
| 5357226-2       | 1   | NIO AMP BRACKET  |
| 5394300-3       | 20  | Nylon Cable Tie, 290mm Long, 3.70mm Wide, RoHS Compliant   |
| 5394300         | 30  | Nylon Cable Tie, 140mm Long, 3.70mm Wide, RoHS Compliant   |
| 5394300-2       | 10  | Nylon Cable Tie, 203mm Long, 2.50mm Wide, RoHS Compliant   |
| 46-136246P14    | 0.3 | 2- WIDE, WHT, ADH BACK, VELCRO LOOP 25 YD  |
| 46-136246P21    | 0.3 | 2- WIDE X 25 YD WHITE VELCRO HOOKS   |
| 5115172         | 1   | Ground Wire Ceiling Plate  |
| 5115171         | 1   | Handle LCD Monitor   |
| 5161926-2       | 1   | Hardware collector for Boom-in-a room, RoHS  |
| 1000-M12C060-04 | 4   | Hexagon Socket Head Cap Screw, M12-1.75, X60mm Long, Grade 8.8 Steel, Zinc Plated, RoHS Fastener |
| 1000-M8C050-07  | 1   | Hexagon Socket Head Cap Screw, M8-1.25, X50mm Long, Grade 12.9 Steel, Black Oxide, RoHS Fastener |

| P/N            | QTY | DESCRIPTION  |
|----------------|-----|--|
| 1007-M4C020-14 | 4   | Phillips Pan Head Screw, ISO 7045, M4-0.7, X20mm Long, Grade 4.8 Steel, Zinc Plated, RoHS Fastener |
| 2000-M12-03    | 8   | Flat Washer, ISO7089, M12, Steel 200HV, Zinc Plated, RoHS Fastener                                 |
| 2000-M4-02     | 6   | Flat Washer, ISO7089, M4, Steel 140HV, Zinc Plated, RoHS Fastener                                  |
| 2000-M8-03     | 2   | Flat Washer, ISO7089, M8, Steel 200HV, Zinc Plated, RoHS Fastener                                  |
| 2203-M12-07    | 4   | Curved Lock Washer, DIN 128A, M12, Spring Steel, Zinc Plated, RoHS Fastener                        |
| 2203-M4-07     | 6   | Curved Lock Washer, DIN 128A, M4, Spring Steel, Zinc Plated, RoHS Fastener                         |
| 2203-M8-07     | 1   | Curved Lock Washer, DIN 128A, M8, Spring Steel, Zinc Plated, RoHS Fastener                         |
| 3000-M12C-04   | 4   | Hexagon Nut, ISO4032, M12-1.75, Grade 8 Steel, Zinc Plated, RoHS Fastener                          |
| 3000-M4C-04    | 2   | Hexagon Nut, ISO4032, M4-0.7, Grade 8 Steel, Zinc Plated, RoHS Fastener                            |
| 3000-M8C-04    | 1   | Hexagon Nut, ISO4032, M8-1.25, Grade 8 Steel, Zinc Plated, RoHS Fastener                           |
| 5394300-4      | 10  | Nylon Cable Tie, 368mm Long, 6.00mm Wide, RoHS Compliant   |
| 5627691        | 1   | Digital Video Splitter kit, power and DVI Cable  |
| 5408703        | 1   | DP to DVI cable, 3 meter   |
| 5641358        | 1   | 3m DVI-D to DVI-D cable, male to male, single link, for display monitor                            |
| 5573770        | 1   | DVI-D to DVI-D dual link cable, male to female, 5m   |
| 5573802        | 1   | power cable for Vedo AMP DVDF200 ACDC  |
| 5548849        | 1   | Power cable for Opticis BPM010S05F07, AWG14  |
| 5548852        | 1   | DVI-D to DVI-D dual link cable, male to male, 5m   |
| 5836007        | 1   | DVI EDID Emulator FRU collector  |
| 5834939        | 1   | DVI EDID Emulator  |
| 5641358-3      | 1   | Video Cable, 0.35 Meter, DVI-D to DVI-D, Male to Male, Single Link                                 |
| 5836007-1EN    | 1   | Installation Instruction of DVI EDID Emulator  |
| 5394300-2      | 5   | Cable Tie  |

**Table 1-4 B7710AN Boom-In-Room Parts List (5115174-20 BOM)**

## Section 4.0 Exam Suite Monitor with LCD Option

### 4.1 Site Preparation

Determine whether the existing cables run through conduit, wire trough or under raised floor, and, if a sufficient opening exists to run the monitor video cable from the operator console to the gantry base.

- Cable Length: 21.6 m (71 ft.) (OC <-> Ceiling Junction Box)
- Minimum 45mm (1.75 in.) hole to route cables between Console and Gantry
- LCD Monitor dimensions (see below).

### 4.2 Component Dimensions

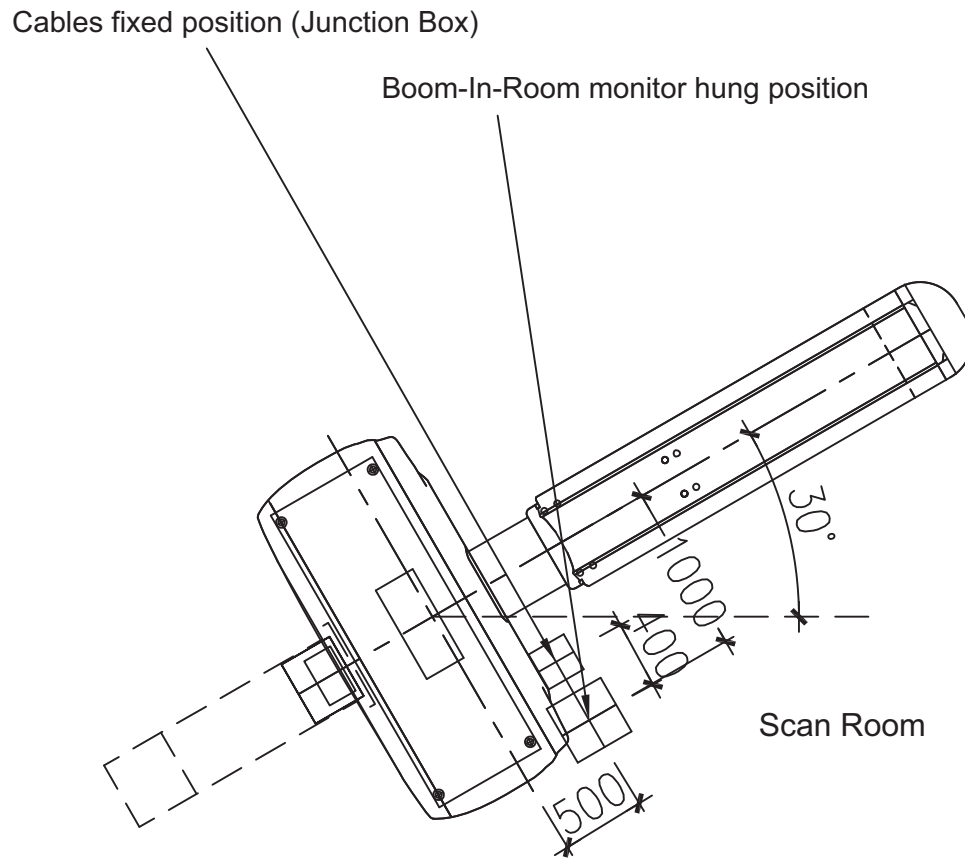
Dimensions listed for Monitor are averages

|               |                    |
|---------------|--------------------|
| MODEL         | P/N 5169069-8      |
| WIDTH         | 405 mm (15.9 in.)  |
| DEPTH         | 61.5 mm (2.4 in.)  |
| HEIGHT/LENGTH | 334 mm (13.1 in.)  |
| WEIGHT        | 5.2 kg (11.5 lbs.) |

**Table 1-5 Eizo Model S1923-H LCD Monitor Dimensions**

|               |                     |
|---------------|---------------------|
| MODEL         | P/N 5746368         |
| WIDTH         | 422.5 mm (16.6 in.) |
| DEPTH         | 61.5 mm (2.4 in.)   |
| HEIGHT/LENGTH | 348.5 mm (13.7 in.) |
| WEIGHT        | 5.5 kg (12 lbs.)    |

**Table 1-6 Eizo Model DIN6868-157 LCD Monitor Dimensions**



Remark:

1. Customer needs to prepare 369x369x12mm steel plate to hang the Boom-In-Room monitor, weight of the arm is 30.9kg, position as shown in above figure.
2. Customer needs to prepare 350x350x8mm steel plate to fix the junction box and ceiling plate assembly, position as shown in above figure.

Figure 1-1 Table and Gantry (Top View) Exam Suite Monitor with Ceiling Mounted LCD

### 4.3 Remote Monitor Power Requirements

**CT Scanner system** using NIO Console/ OpenOC Console/ Standalone Console require IEC power plugs or adaptor kit (B7820HD) to supply the power. The LCD monitor and video splitter receives it's power from the Operator Console. Ground Remote Monitor to the console ground stud.

# Chapter 2

## Boom Installation

### Section 1.0 Introduction

Follow the manufacturer's shipped boom and arm installation directions to attach the pedestal assembly to the customer installed ceiling mounting plate.

- Assemble and install the pedestal to the ceiling mounting plate (customer installation responsibility) using the supplied hardware.
- With the pedestal column installed, follow the manufacturer's shipped directions to install the extension spring arm and LCD monitor mounting post.
- Perform EDID programming for splitter (Skip this step if EDID emulator in kit).
- Attach the supplied LCD monitor post using the manufacturer's shipped directions.
- Attach the LCD monitor to the post using the directions found in this manual.
- Install the cables and cable cover between the monitor and the ceiling junction box. Connect this wiring to the ceiling junction box.
- Route the LCD power, ground, and video cables to the rear of the operator console. Connect this wiring to the ceiling junction box.
- Install the splitter assembly and EDID emulator (if EDID emulator in kit) to the console chassis. Route and connect its power and signal cables.
- Connect the power cable to the console's outlet box.
- Connect the ground cable to the console grounding lug.

### Section 2.0 Required Tools

Be sure these tools are available before installing the boom.

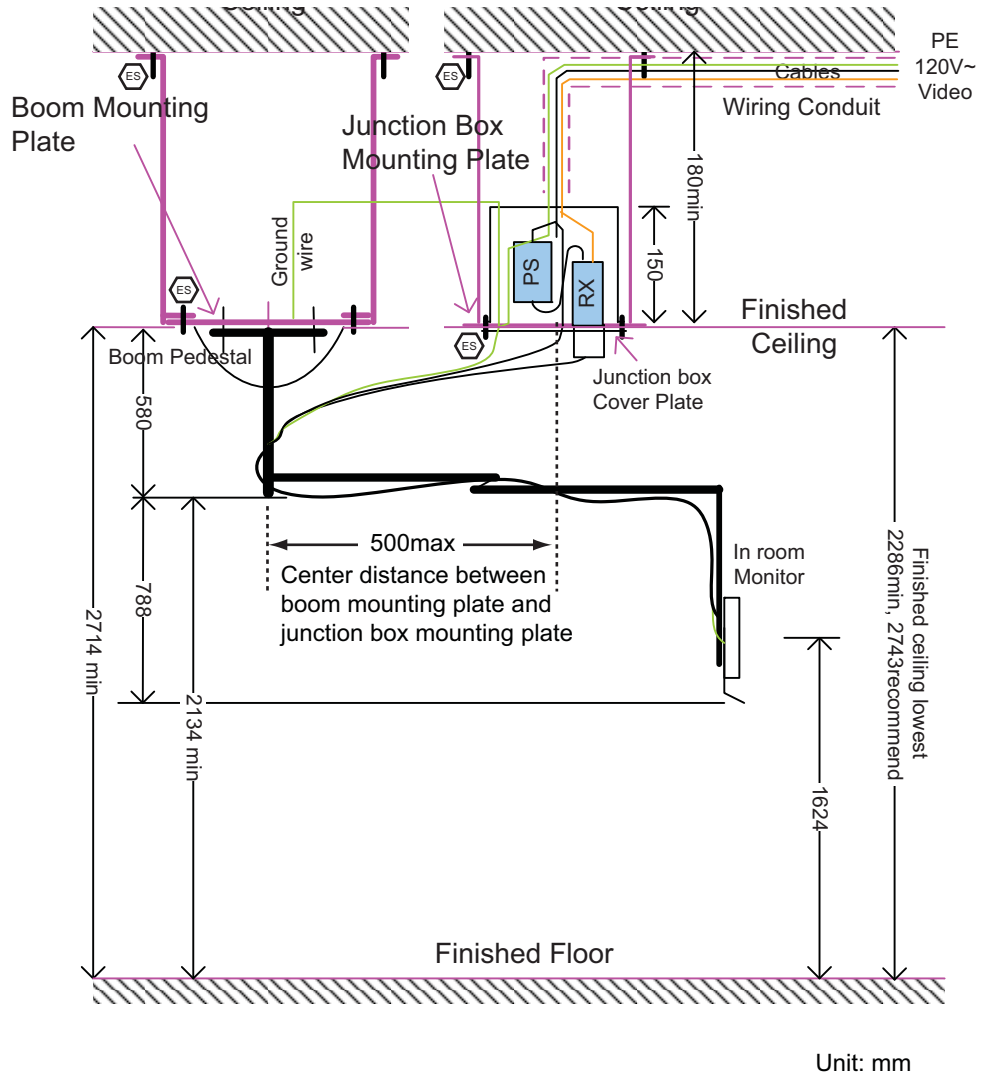
|   |                                |
|---|--------------------------------|
| Step Ladder, 6' - 8'                          | Side Cutters                   |
| 3/8" Ratchet Set (SAE/Metric)                 | Wire Stripper                  |
| Allen Wrench Set                              | Dale 600 meter (or equivalent) |
| Screwdrivers, Phillips and Standard (+ and -) | Fluke 87 meter (or equivalent) |

Table 2-1 Required Tools

### Section 3.0 Personnel Requirements

Two Field Engineer for 6 hours at field plus 1 hour travel time.

# Section 4.0 Boom Installation Typical Layout



**Figure 2-1 Boom-In-Room Typical Layout**

Note: The center distance between the junction box mounting plate and the ceiling mounting plate is no more than 0.5 meter. (See [Figure 2-1 Boom-In-Room Typical Layout](#))

## Section 5.0 Installation Requirement

### 5.1 Regulatory Requirement

The system with suspension option (Depth Camera or Boom-In-Room, ect...), the overhead suspension shall be installed by strictly following the GEMS installation instructions. The system manufacturer specifically disclaims any and all liability arising out of or relating to the use or performance of the Junction Plate/Pedestal Base, including, without limitation, any liability or claims relating to patient injury, death or the reliability of such suspension.

Where a Junction Plate is supplied and installed by the purchaser of the system, the installation plate should comply with applicable regulations enforced in the country.

### 5.2 Junction Plate Requirement



**WARNING**

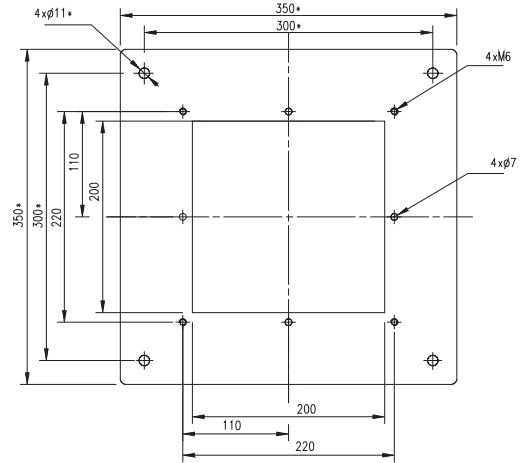


The customer's architect is responsible for designing and installing two mounting plates with sufficient strength to hold the junction box and boom/monitor assembly. Suggest the safety load on the junction box mounting plate and the boom mounting plate are no less than 4 times load.

Please follow torque requirement as shown below:

- 7.9Nm for M6 fastener
- 19.2Nm for M8 fastener
- 38.4Nm for M10 fastener
- 66.4Nm for M12 fastener

Junction Box Mounting Plate



THE DIMENSIONS WITH \* IS ONLY FOR CUSTEMOER REFERENCE

Boom Mounting Plate

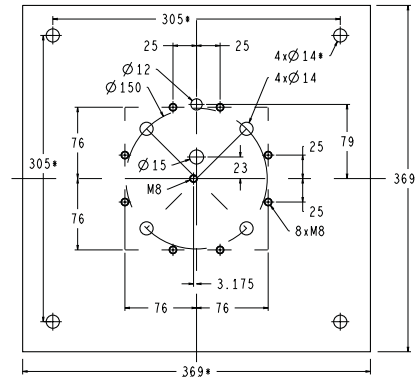


Figure 2-2 Junction Box Mounting Plate and Boom Mounting Plate

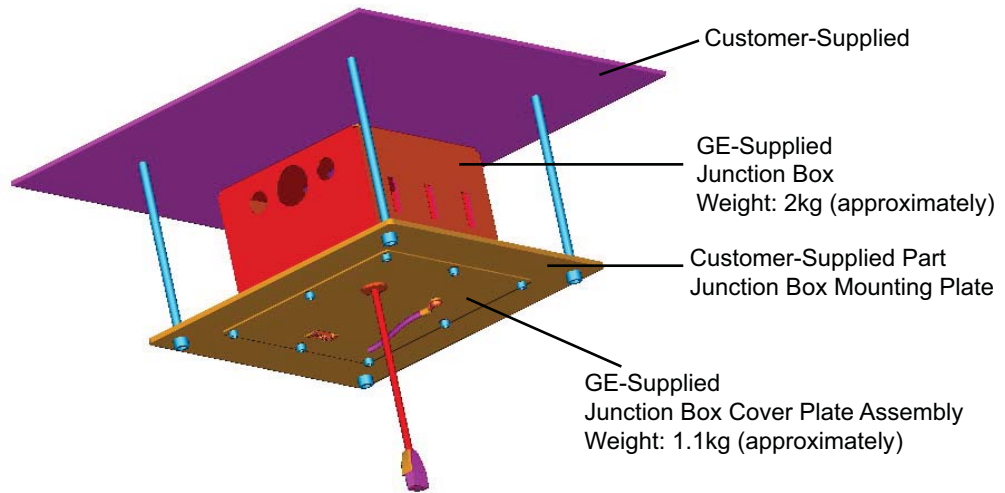
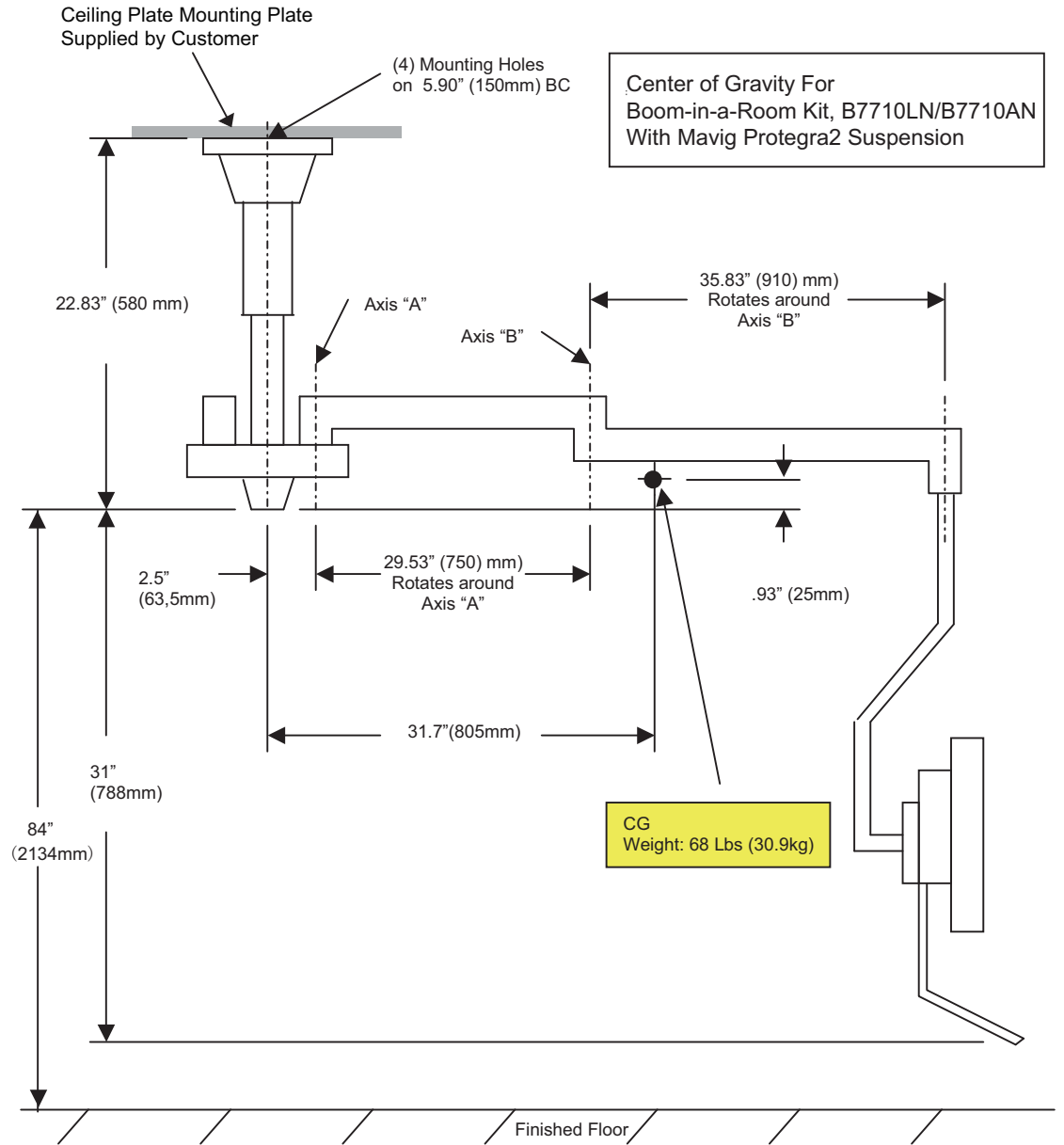


Figure 2-3 Weight Information of Junction Box Assembly



**Figure 2-4 Boom-In-Room Arm Size and CG**

**NOTICE** For load consideration, [Figure 2-3](#) and [Figure 2-4](#) only show weight of GE-Supplied parts, the customer's architect needs to consider weight of customer-supplied parts.

# Section 6.0 Installation Tips

**WARNING** **DANGER OF PERSONAL INJURY.**  
**INJURY OR DEATH CAN OCCUR FROM FALLING FROM LADDER.**  
**FOLLOW ALL SAFETY PRECAUTIONS WHEN WORKING ON A LADDER.**



**WARNING** **CRUSH HAZARD.**  
**HEAVY COMPONENTS CAN FALL, CAUSING PERSONAL INJURY OR DAMAGE TO EQUIPMENT.**  
**USE TWO PEOPLE TO INSTALL THE BOOM.**



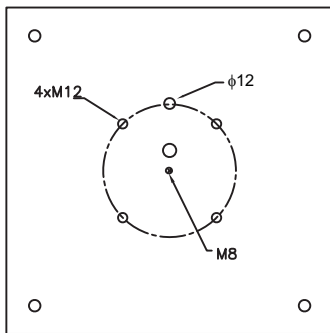
## 6.1 Boom Pedestal Installation

Use the manufacturer's supplied instructions and the following tips, to install the **boom pedestal**:

**WARNING** **CRUSH HAZARD**  
**HEAVY COMPONENTS CAN FALL, CAUSING PERSONAL INJURY OR DAMAGE TO EQUIPMENT.**  
**USE TWO PEOPLE TO ATTACH THE BOOM PEDESTAL.**



- 1.) Five (5) mounting holes are required to install the boom pedestal to the boom mounting plate. Four (4) M12 with flat washers, lock washers, and hex nut are used. One M8 is used to anchor the safety chain bracket assembly. One  $\phi 15$  hole is used for the ground cable connection.



**Figure 2-5 Boom Mounting Plate (5 mounting holes for pedestal fixing)**

- 2.) The pedestal cover is attached with screws to allow the cover to be lowered for installation. If a power cord is present, it must be cut before installing the pedestal. See [Figure 2-6](#).



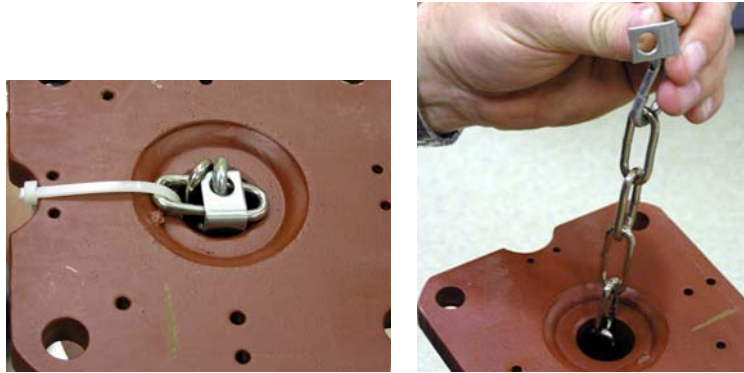
**Figure 2-6 Ceiling Pedestal**

Note: Determine the proper orientation for the boom arm assembly before mounting the pedestal to the boom mounting plate. See [Figure 2-7](#) (example).



**Figure 2-7 Boom Orientation**

- 3.) When attaching the safety chain ([Figure 2-8](#)), be sure the M10 bracket hardware is properly torqued. The torque for the M8 is 19.2N-m (14.2 ft-lbs).



**Figure 2-8 Safety Chain**

- 4.) The pedestal is installed using four (4) M12 bolts. Install a flat washer over the bolt, then insert the bolt through the pedestal and the boom mounting plate. Add another flat washer, a lock washer and hex nut. Torque the M12 bolts to 66.4 N-m (49 Ft-lbs). See [Figure 2-9](#).



**Figure 2-9 Pedestal Installed**

- 5.) Install the ceiling pedestal cover, but leave the ceiling open — a ground wire will be added later. Install the bottom pedestal cover by snapping it together. See [Figure 2-10](#)



**Figure 2-10 Pedestal Cover Installation**

## 6.2 Boom Arm Assembly Installation

Use the manufacturer's supplied instructions and the following tips, to install the **boom arm assembly**:

- 1.) After removing the covers from both the pedestal mount and the arm assembly, install the arm using the manufacturer's supplied procedures.



**Figure 2-11 Hardware for attaching arm**



**Figure 2-12 Attaching Arm to Pedestal**



**Figure 2-13 E-ring Tool**

- 2.) The monitor mounting bracket should fit snugly into the arm assembly. Be sure to follow the supplied manufactures instructions when completing this assembly.



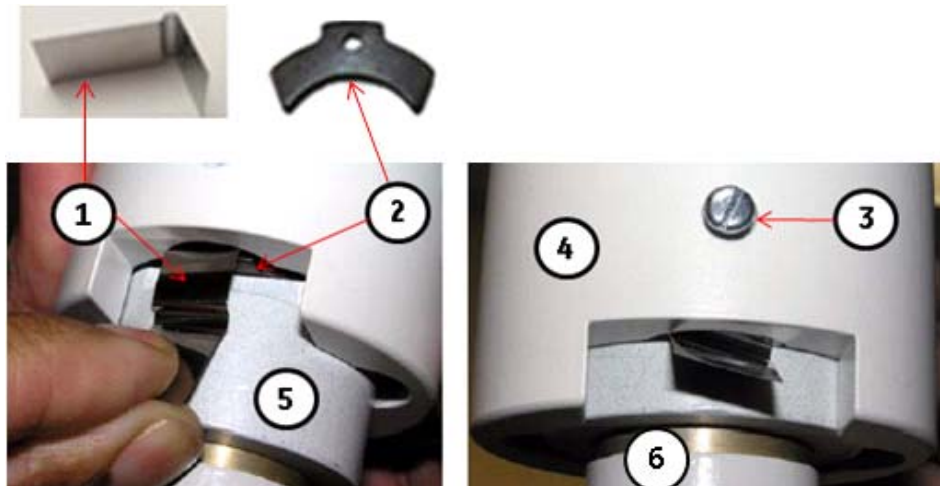
**Figure 2-14 Install LCD Monitor Post**

**WARNING**



Always use a new safety spring.

The safety spring must be installed properly by sliding the long end between the LCD monitor mount post retaining clip and safety collar. Failure to install this safety spring properly could result in the monitor and post suddenly disconnecting, causing damage or personal injury.



**Figure 2-15 Safety Spring and Screw**

|   |  |
|---|--|
| 1 | Safety Spring  |
| 2 | Retaining Clip   |
| 3 | Retention Screw (For safety spring and retaining clip) |
| 4 | Safety Collar  |

**Table 2-2 Description of Items from Figure 2-12**

|   |                                   |
|---|-----------------------------------|
| 5 | Receptacle                        |
| 6 | LCD monitor mount post (Receiver) |

**Table 2-2 Description of Items from Figure 2-12**

### 6.3 Junction Box Cover Plate Assembly Installation

Following the tips below, to complete the **Junction Box Cover Plate Installation**:

- 1.) The junction box is mounted on the junction box mounting plate (customer supplied) should be next to the pedestal.
- 2.) Place the junction box on the junction box mounting plate using four M6 mounting screws. (See [Figure 2-18](#))
- 3.) Plate three cables (power cable, optical fiber cable and ground cable) through cable hole of the junction box. (See [Figure 2-18](#))



Ground Cable (5116219)  
 - From Ceiling Plate  
 - to OC Chassis

Power Cable (2213219)  
 - From Ceiling Plate  
 - to Change-Over Power Cable

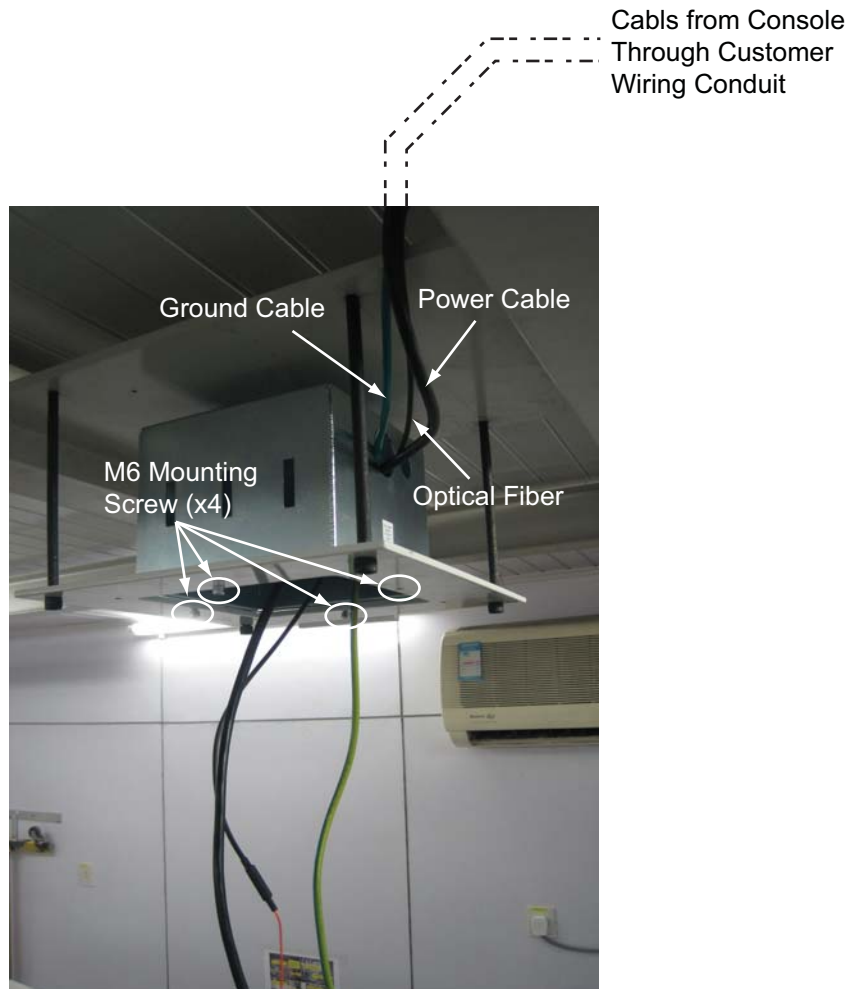
Optical Fiber (5573673)  
 - From Ceiling Plate Vedo Receiver  
 - to AC Box

**Figure 2-16 Power Cable, Optical Fiber and Ground Cable**

Note: Need to deal with the power cable (2213219) before routing, remove the scarfskin of power cable as shown below figure.

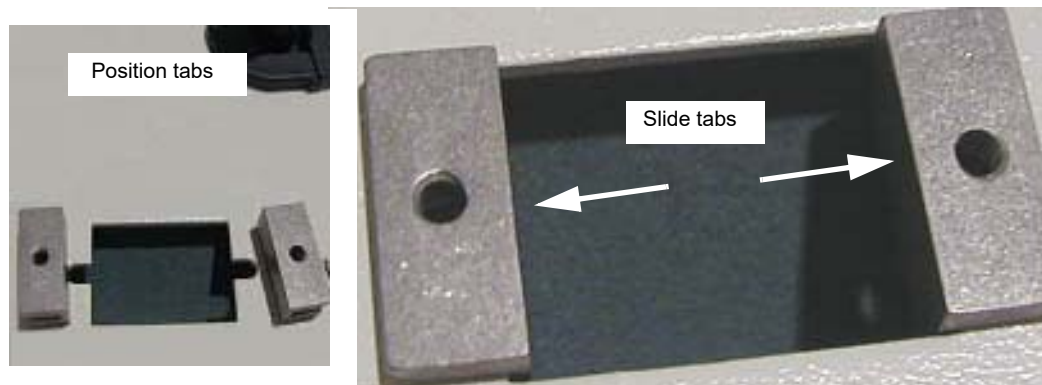


**Figure 2-17 Remove the Scarfskin of Power Cable**



**Figure 2-18 Route Three Cables**

- 4.) Route three cables (power cable, optical fiber cable and ground cable) through conduit from the scan room to the operator room.
- 5.) Place the connector tabs onto the cover plate in the location for the video cabling. Firmly slide them into place so that the slot in each tab fits over the plate and their holes line up with the holes in the cover plate. (See [Figure 2-19.](#))



**Figure 2-19 Installing Video Connector Tabs**

- 6.) Use two Nylon cable ties to fix the adapter on the junction box cover plate and install the receiver on the junction box cover plate.



**Figure 2-20 Adapter for Receiver**

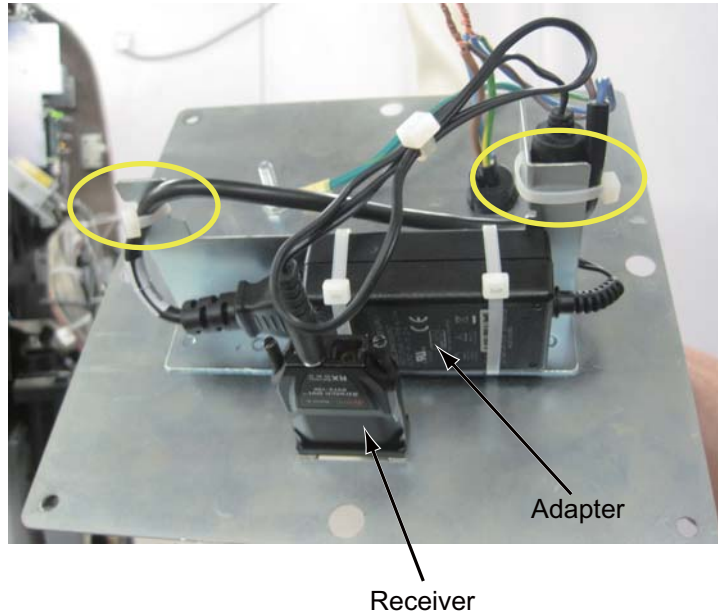
- 7.) Connect the power cable for the receiver as shown below figure.



Power Cable\_In  
(5548849)

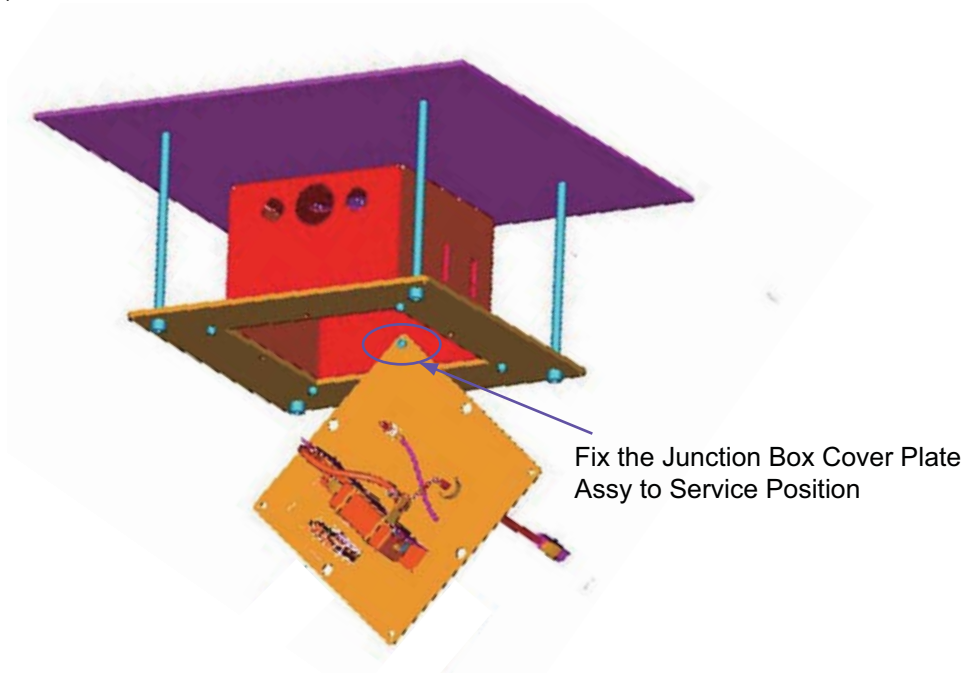
**Figure 2-21 Power Cable Connection**

- 8.) Use Nylon cable ties to fix cables on the junction box cover plate assembly.



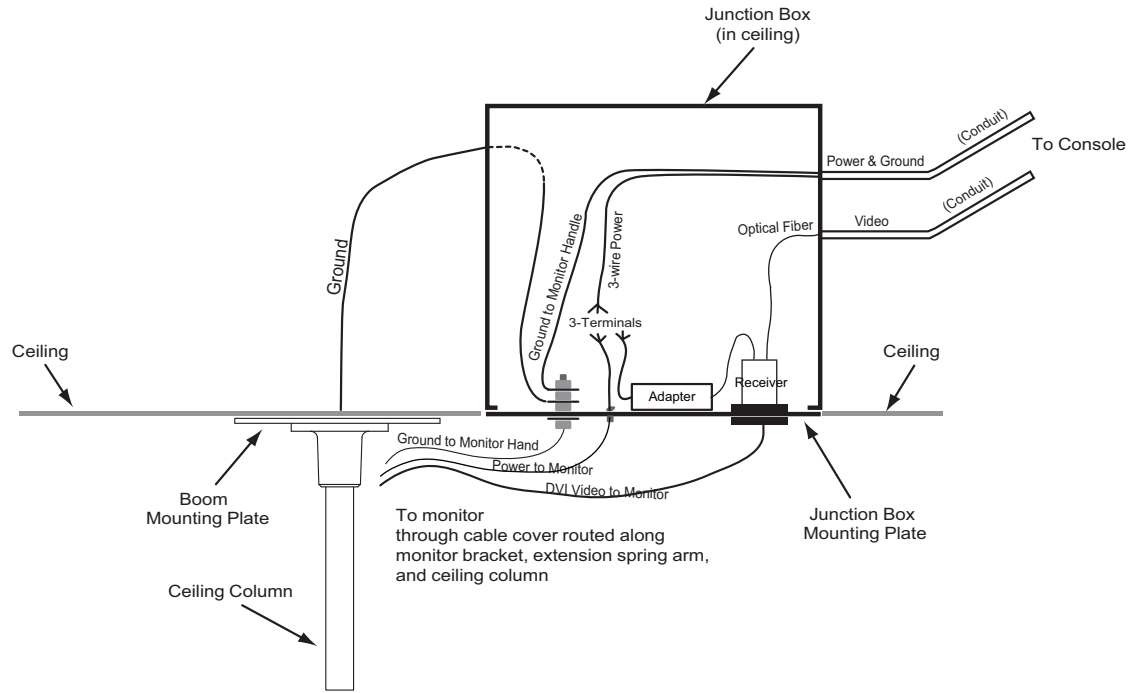
**Figure 2-22 Junction Box Cover Plate Assembly**

- 9.) Fix the junction box cover plate assembly to the service position of the junction box using one (1) M6 screw.

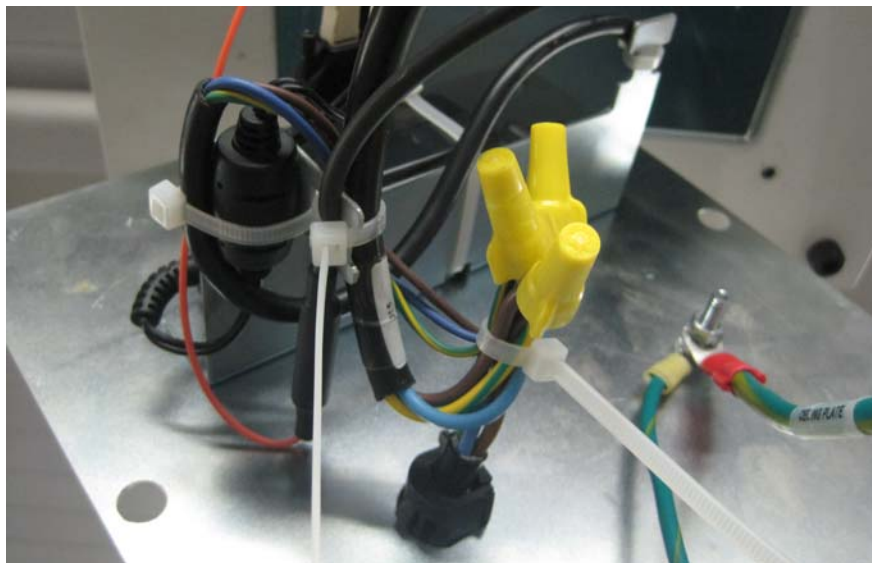


**Figure 2-23 Fix the Junction Box Cover Plate Assy to Service Position**

- 10.) Bunch power cables (receiver power cable, remote monitor power cable and master input power cable from console) according to their color (blue to blue, brown to brown and green-yellow to green-yellow) using three terminals as shown below figure. Tighten three terminals by turning them clockwise until secure, and make sure no copper wires exposed.



**Figure 2-24 Monitor Cables at Junction Box**



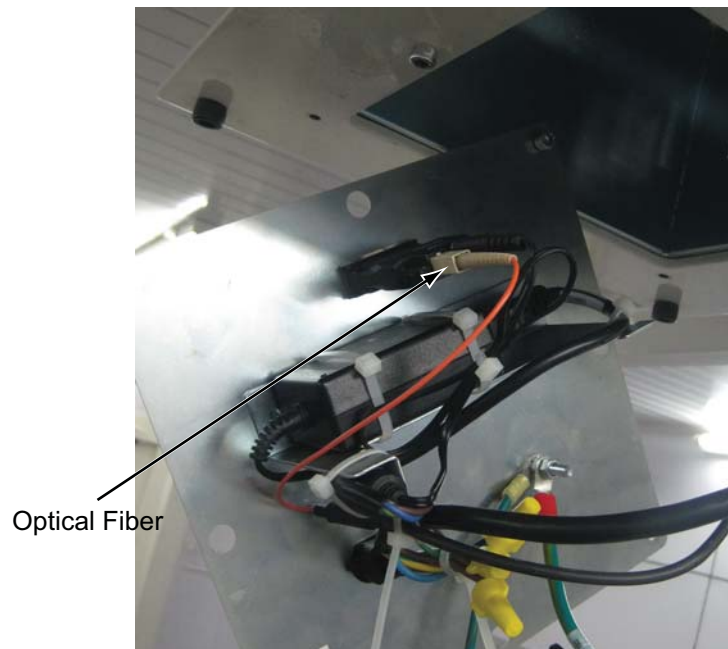
**Figure 2-25 Bunch three Power Cables**

11.) Connect the ground cable (5116219) to the junction box cover plate.



**Figure 2-26 Ground Cable Connection**

12.) Insert the optical fiber cable (5573673) to the receiver.



**Figure 2-27 Optical Fiber Cable Connection**

13.) Make sure all cables are fixed well, no interference and bare cable.

14.) Remove the junction box cover plate assy from its service position, then install it to the junction box mounting plate using four (4) M6 mounting screws.

Note: Try to connect the DVI video cable to the receiver before fixing the junction box cover plate, see [Figure 2-38](#) for DVI video cable connection, adjust receiver screws position if DVI video cable can't be fixed tightly.



- for Junction Box Attaching
- for Junction Box Cover Plate Attaching

**Figure 2-28 Junction Box Cover Plate Assembly Installation**

15.) Some installers may choose to install the video splitter in the console on the right side. Route the cables from the wall box into the console.

## 6.4 Arm Balancing Adjustment

Use the manufacturer's supplied instructions and the following tips below, to complete the **arm balancing**:

- When balancing the arm, be sure to have all cables routed on the assembly, and the cable dressed in the supplied cable cover. Leave enough of a loop to allow full vertical and horizontal motion when done.
- Adjustment locations are shown in the figures below.



Figure 2-29 Vertical Adjustment

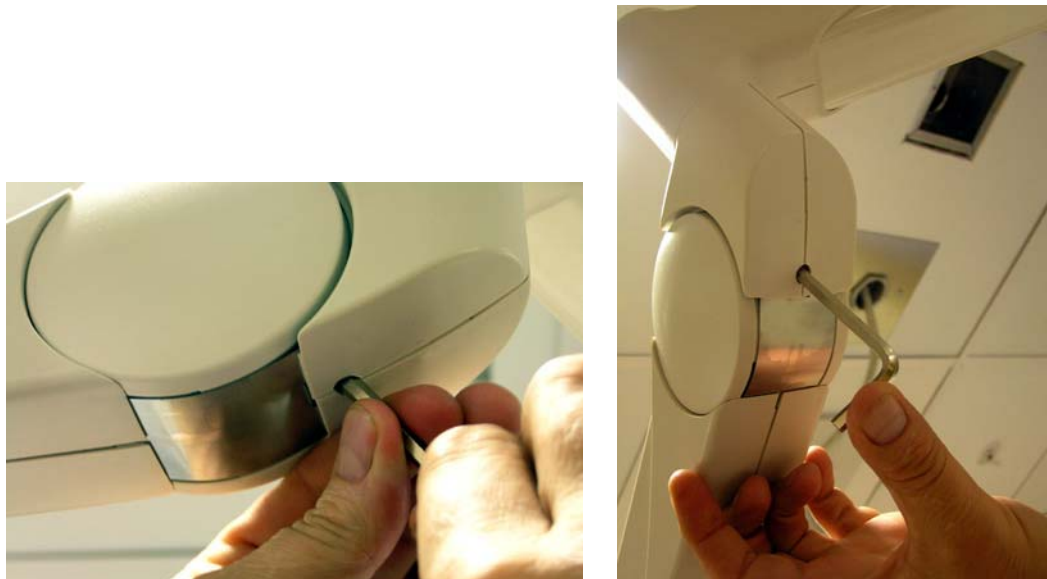


Figure 2-30 Balance Adjustment

## Section 7.0 EDID Programming or Configuration

### 7.1 EDID Programming for Splitter

**NOTICE** If it contains Emulator Kit (5836007) in purchased Boom-In-Room Kit (B7710AN), please ignore this section, and go to [7.2 DVI EDID Emulator Setting](#).

- 1.) Unpack the Remote/In-Room monitor package and position it to the operator room to set EDID.
- 2.) Connect the splitter power cable and power on the splitter DVDF-200.
- 3.) Press the splitter DVDF-200 EDID button.



**Figure 2-31 Splitter**

- 4.) "Status" LED of the splitter flashes 3 times, then keeps ON.
- 5.) Connect the In-Room monitor power cable and power on the Remote/In-Room monitor.
- 6.) Connect DVI video cable between the splitter DVD-200 DVI OUT port and the Remote/In-Room monitor.
- 7.) "Status" LED of the splitter flashes rapidly, then OFF after 7~8 seconds.
- 8.) EDID programming is completed.

**NOTICE** Please go to [Section 8.0 Remote Monitor Installation](#) for following process when you finished all steps in Section 7.1.

### 7.2 DVI EDID Emulator Setting

**NOTICE** If it does not contain Emulator Kit (5836007) in purchased Boom-In-Room Kit (B7710AN), please ignore this section.



**Figure 2-32 Panel Switch**

- 1.) The DIP switches are all “ON”.



**Figure 2-33 DIP Switch**

- 2.) According to actual display resolution, set the rotary switch to appropriate position as below [Table 2-3](#).

| Rotary Switch Position | Resolution   |
|------------------------|--|
| 0                      | User Recorder EDID                                       |
| 1                      | 800 x 600  |
| 2                      | 1024 x 768   |
| 3                      | 1280 x 720   |
| 4                      | 1280 x 768   |
| 5                      | 1280 x 800   |
| 6                      | 1280 x 1024  |
| 7                      | 1360 x 768   |
| 8                      | 1366 x 768   |
| 9                      | 1400 x 1050  |
| A                      | 1440 x 900   |
| B                      | 1600 x 1200  |
| C                      | 1680 x 1050  |
| D                      | 1920 x 1080  |
| E                      | 1920 x 1200  |
| F                      | <b>Digital:</b> Dual Link DVI<br><b>Analog:</b> Not Used |

**Table 2-3 Resolution for Rotary Switch Position**

For example, set the rotary switch to "6" for 1280x1024 resolution.



Figure 2-34 Switch to Pin 6

## Section 8.0 Remote Monitor Installation

### 8.1 Monitor Installation

#### WARNING

#### CRUSH HAZARD



**HEAVY COMPONENTS CAN FALL, CAUSING PERSONAL INJURY OR DAMAGE TO EQUIPMENT.**

**USE TWO PEOPLE TO ATTACH THE MONITOR.**

#### NOTICE



If customer has been purchased BOOM-In-Room Kit (B7710AN) and DIN6868-157 19 inch LCD Monitor Option Kit (B75112CC), FE should use DIN6868-157 19inch LCD monitor for remote/in-room monitor installation. Please refer to DIN6868-157 19inch LCD Monitor Option Installation Manual (5798612-1EN) for the detailed information.

Following the instructions below, assemble the LCD bracket, the monitor handle, the LCD monitor, and the ground cable.



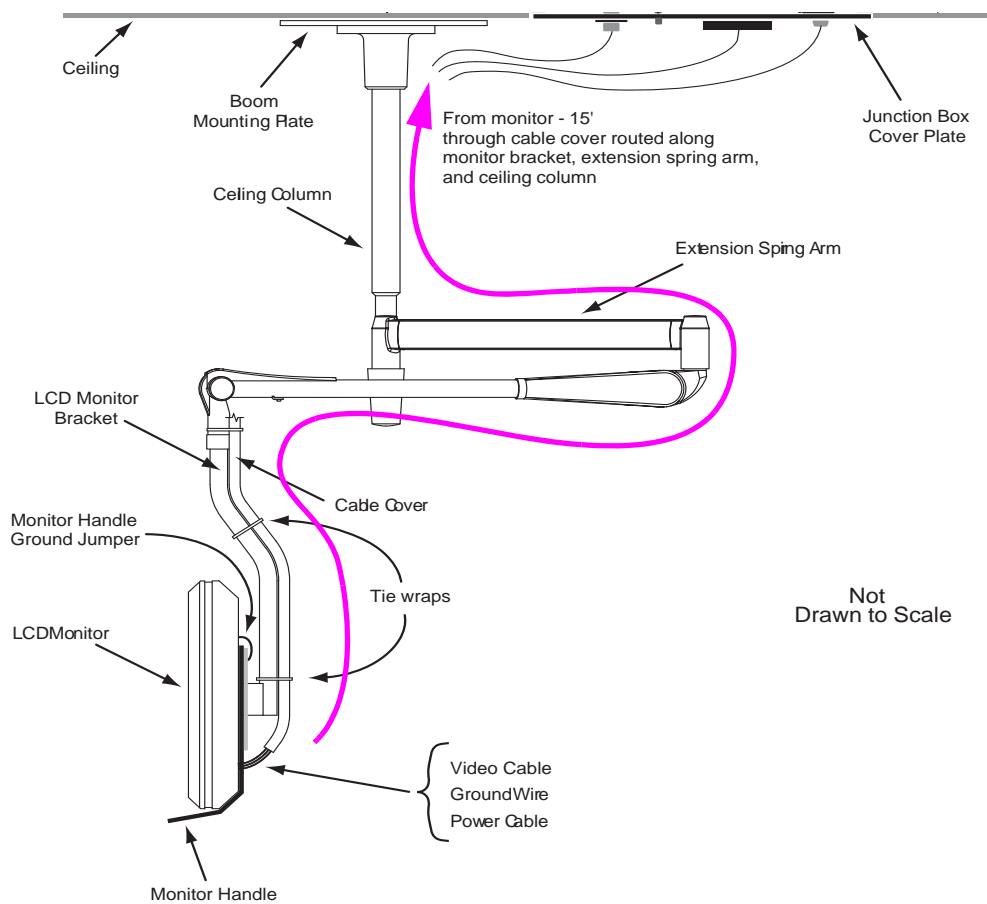
Figure 2-35 Monitor Installation

- 1.) Remove the monitor stand from the monitor.
- 2.) Assemble the bracket, handle, and monitor using the four mounting screws as shown in [Figure 2-35](#). For each of the four mounting holes, apply a thin bead of red Loctite 242 to one of the M4x20mm mounting screws and then install the screw, a flat washer and a lock washer as shown in [Figure 2-36](#)

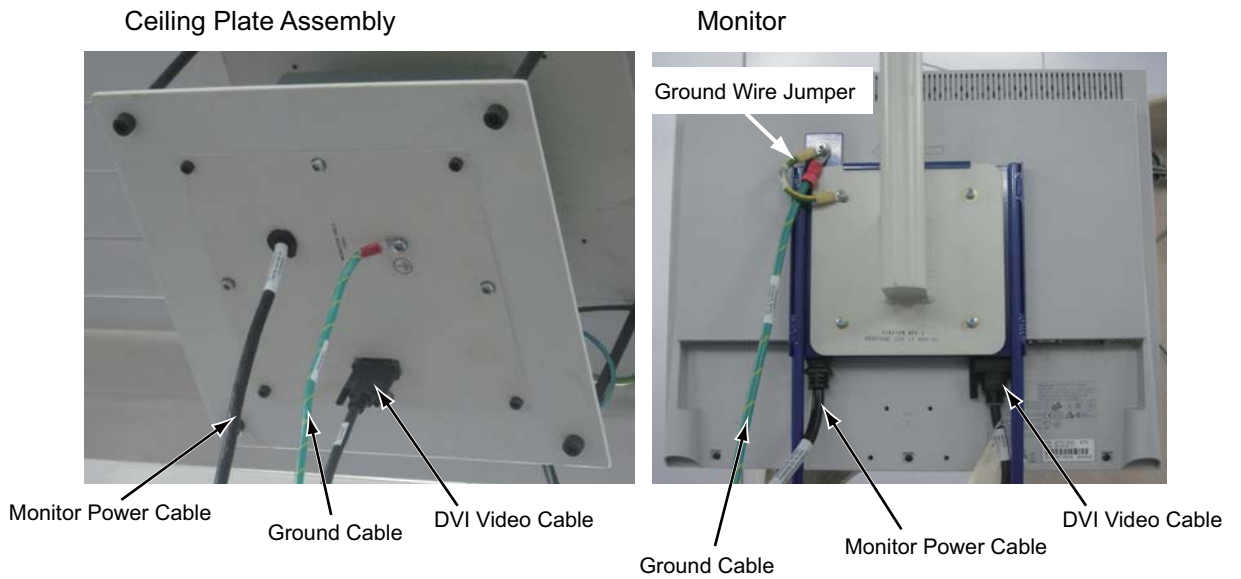


**Figure 2-36 M4x20 Mounting Screw (shown installed at right)**

## 8.2 Route and Connect Monitor Cables

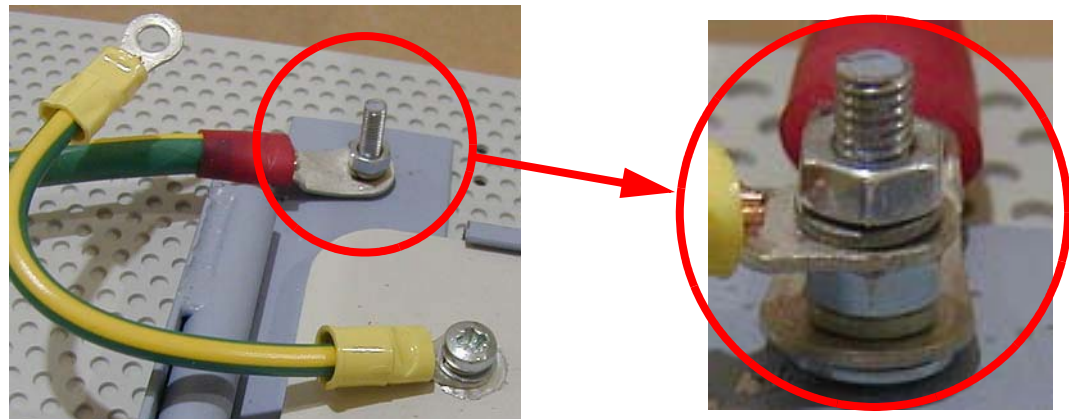


**Figure 2-37 LCD Monitor Assembly with Cables and Cover**



**Figure 2-38 Remote Monitor Cables Connection**

- 1.) Connect the DVI video cable (5573770) between the ceiling plate assembly and LCD monitor.
- 2.) Connect the monitor power cable to the rear of the LCD monitor.
- 3.) Connect the ground cable and the ground wire jumper (5115172) to the ground stud on the monitor handle bracket as shown in [Figure 2-39](#).



**Figure 2-39 Monitor Grounding Wire**

- 4.) Use the cable cover (2212717) to wrap the above three cables (power cable, video cable and ground cable).
- 5.) Route the cables along the boom arm through cable cover as shown in [Figure 2-37](#). Leave enough slack at each joint (**especially for DVI video cable from receiver**) to permit the full range of motion without stretching individual cables.
- 6.) Use Nylon cable ties to fix cables on the boom arm, the **finished assembly** should look similar to that shown below (example).



**Figure 2-40 Completed Assembly (Example)**

Note: Pay attention to the fixed cables don't interfere with movement of the boom arm.

## Section 9.0 Before You Begin

- Review local electrical codes regarding cable routing and electrical box cover plates.
- Order the appropriate kit for your system. (Review applicable catalog numbers in [Chapter 1.](#))
- Identify the remote monitor location.

**DANGER**



**ELECTROCUTION HAZARD**

**WORKING ON ENERGIZED EQUIPMENT CAN RESULT IN ELECTROCUTION OR DEATH.**

**ALWAYS TAG AND LOCK OUT POWER TO THE SYSTEM AT THE “MAIN” DISCONNECT. DO NOT APPLY POWER TO THE SYSTEM UNTIL ALL WORK IS COMPLETE AND ALL COVERS REPLACED.**

Before performing any of the installation procedures described in this section, do the following:

- 1.) Power down the system.
- 2.) Perform Lock-Out/Tag-Out.

# Section 10.0 Operator Console Connection

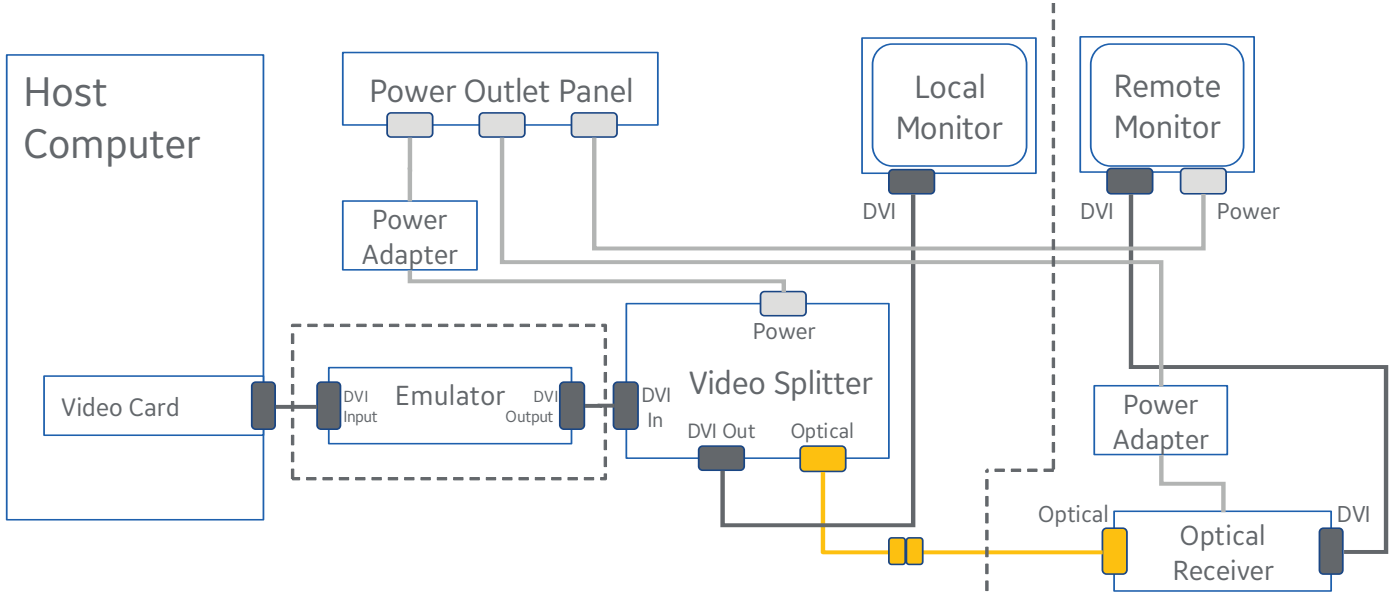


Figure 2-41 Function Diagram

## 10.1 NIO Console with Z820/Z840 Host Computer

- 1.) Remove the console covers.
- 2.) Remove the cable bracket assy by unscrewing its two (2) screws.
- 3.) Remove the AC box top cover by unscrewing its four (4) screws.

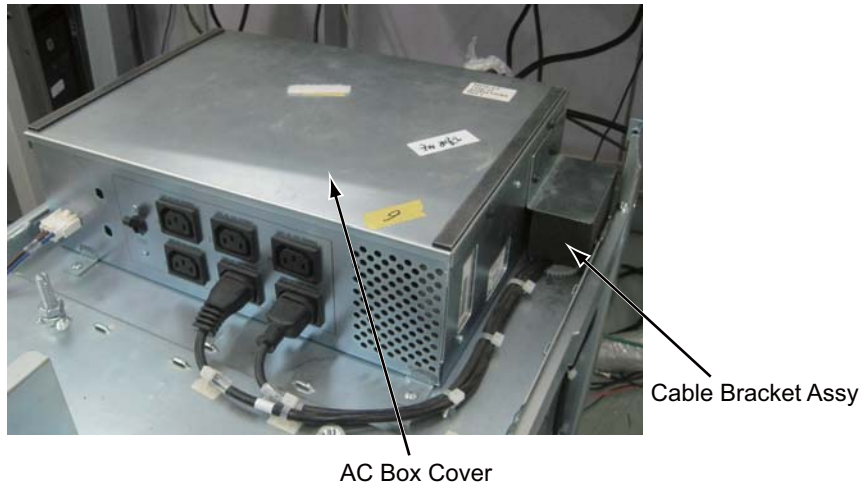


Figure 2-42 AC Box Top Cover and Cable Bracket Removal

- 4.) Install the fiber connector to the AC box.



**Figure 2-43 Fiber Connector Installation**

- 5.) Attach the velcro loops and hooks (46-136246P14 and 46-136246P21) to the HUB bracket, adapter and splitter as shown below figure.



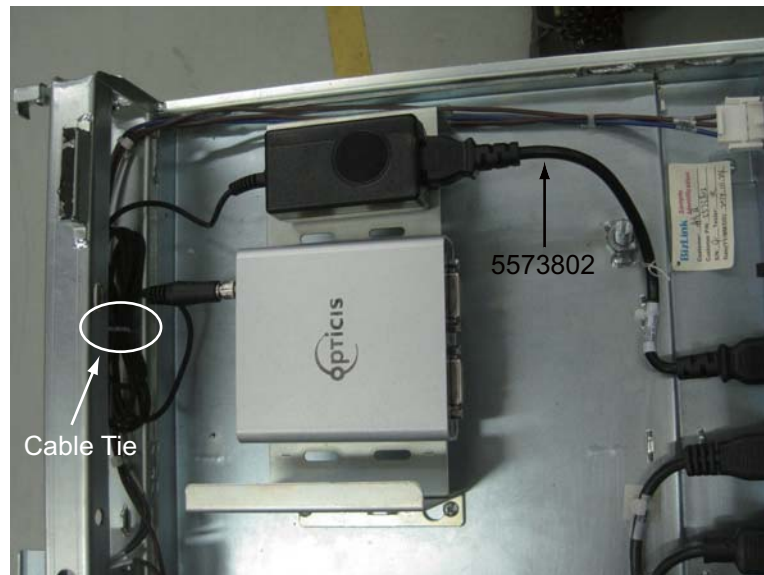
**Figure 2-44 Attach Velcro**

- 6.) Attach the adapter and splitter onto the HUB bracket, and use Nylon cable tie to fix them.

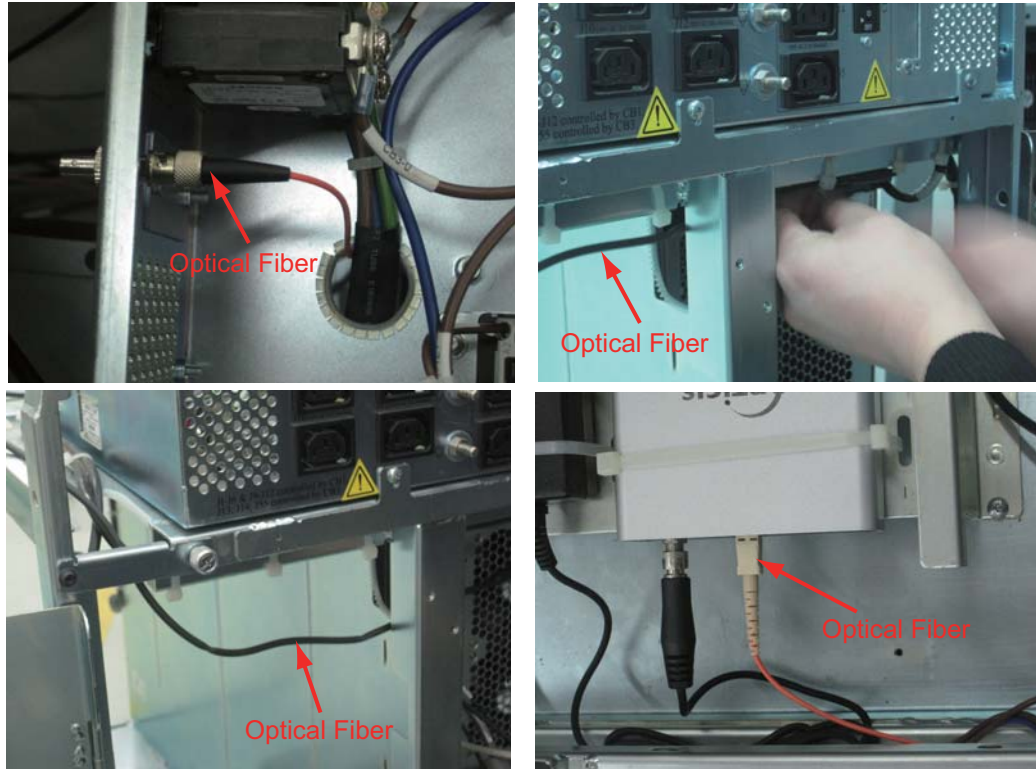


**Figure 2-45 Attach Adapter and Splitter**

- 7.) Connect the power cable (5573802) between the adapter and the AC box outlet **J3**.
- 8.) Connect the power cable to the splitter.
- 9.) Use Nylon cable tie to fix the power cable to the OC chassis.



10.) Route and connect the optical fiber between the AC box fiber connector and the splitter.



11.) Re-install the AC box top cover by screwing its four (4) screws.

**NOTICE** If it does not contain Emulator Kit (5836007) in purchased Boom-In-Room Kit (B7710AN), please ignore Step 12 to Step 15, skip to Step 16 directly.

12.) Adhere the Velcro Strips (hook side) on emulator rear surface.

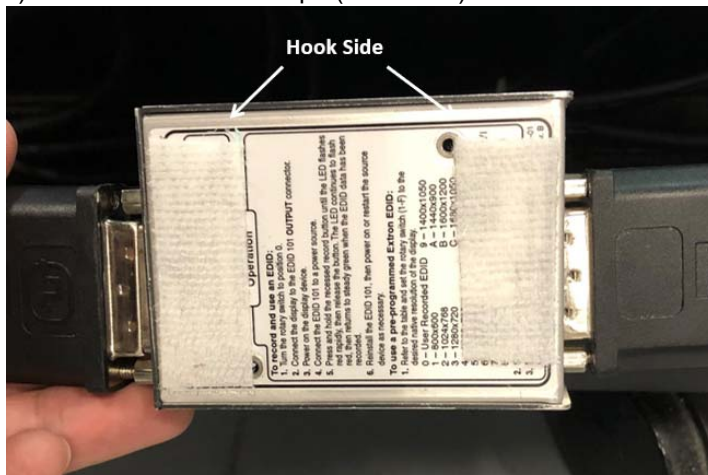
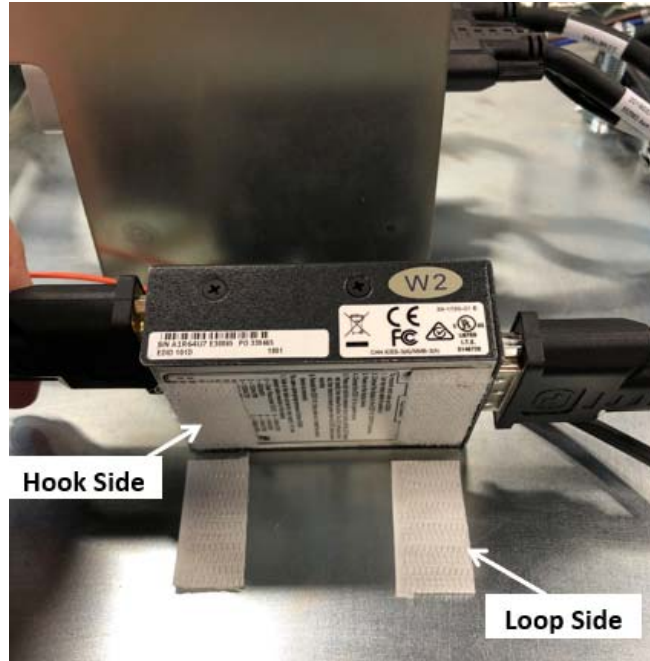


Figure 2-46 Velcro Strips on Emulator

13.) Adhere the Velcro Strips (loop side) on NIO Console chassis top surface, near the splitter bracket.

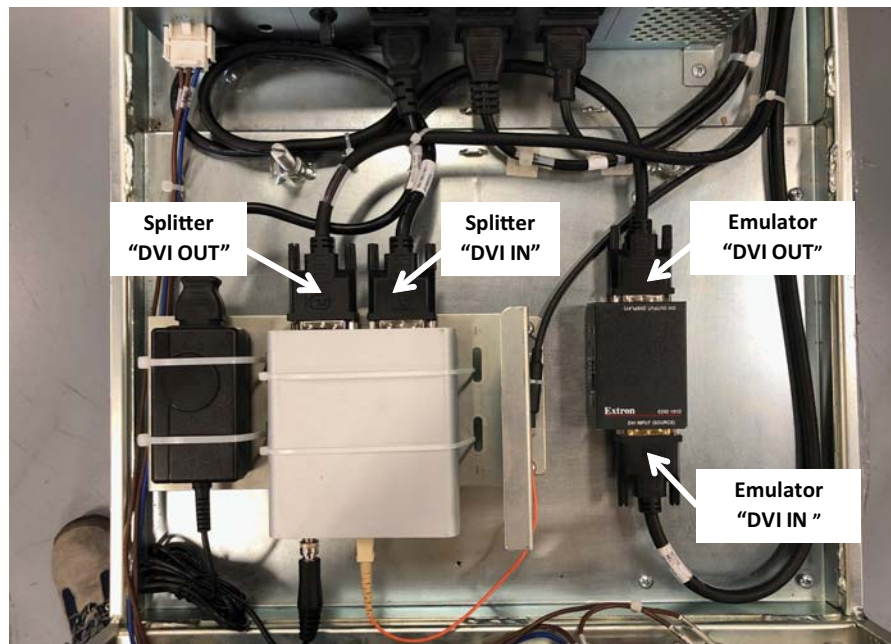


**Figure 2-47 Velcro Strips on NIO Console**

14.) Attach the Velcro loop side and hook side to install the DVI emulator.

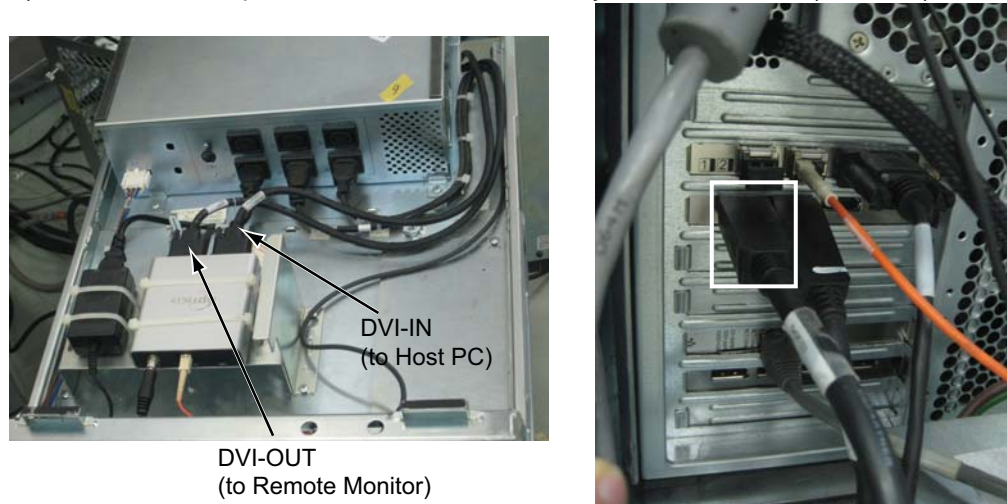
15.) Connect three DVI video cables.

- a.) Connect video splitter "DVI OUT" and local LCD monitor by 5m DVI-D to DVI-D cable (5548852).
- b.) Connect video splitter "DVI IN" port and emulator "DVI OUT" port by 0.35m DVI-D to DVI-D cable (5641358-3).
- c.) Connect emulator "DVI IN" and Host PC by DP to DVI cable (5408703).



**Figure 2-48 DVI Video Cable Connection (With Emulator)**

- 16.) Connect two DVI video cables.
  - a.) Connect video splitter "DVI OUT" and local LCD monitor by 5m DVI-D to DVI-D cable (5548852).
  - b.) Connect video splitter "DVI IN" and Host PC by DP to DVI cable (5408703).

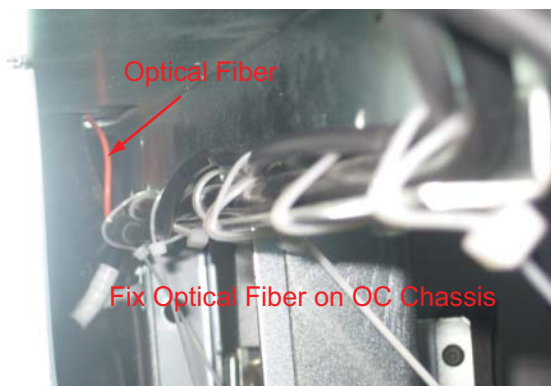
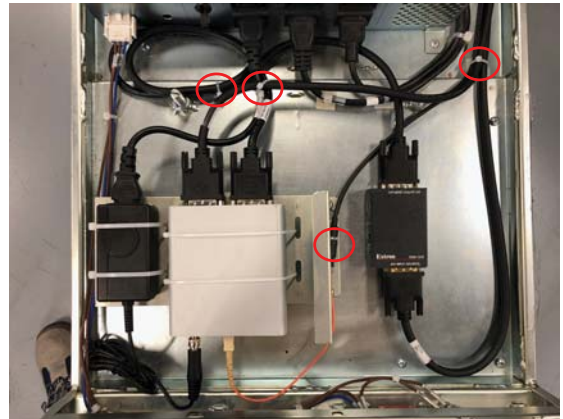


**Figure 2-49 DVI Video Cable Connection (Without Emulator)**

- 17.) Route all DVI video cables and the optical fiber as below figures shown.

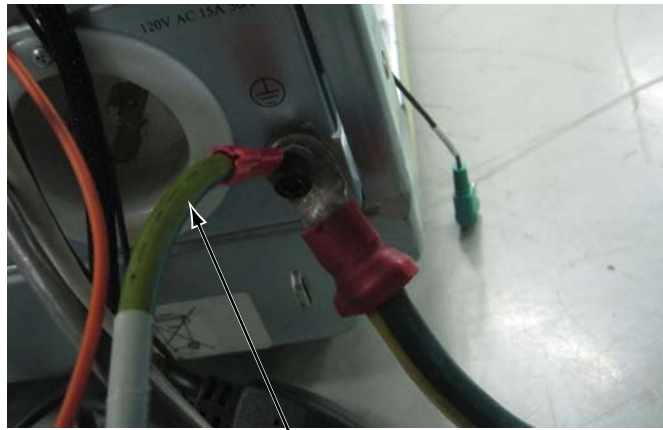
**Without Emulator**

**With Emulator**



**Figure 2-50 Route DVI Video Cables and Optical Fiber**

- 18.) Connect three cables (power cable, optical fiber and ground cable) of the boom-in-room assembly routed in [6.3 Junction Box Cover Plate Assembly Installation, Step 4](#) to console.
- Power Cable to AC Box **J12**
  - Optical Fiber to AC Box fiber connector
  - Ground Cable to OC Chassis
  -



**Figure 2-51 Boom-In-Room Cable**

- 19.) Re-install the OC covers.

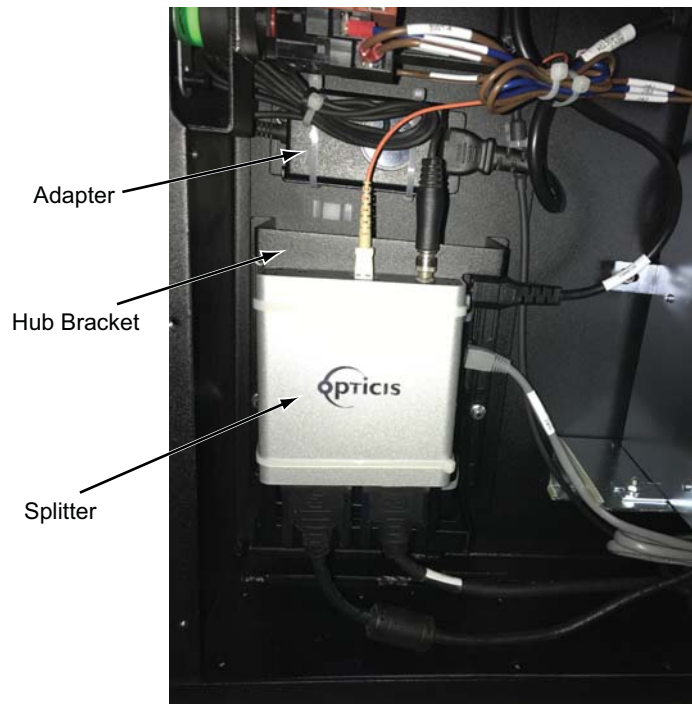
## 10.2 OpenOC Console with Z840/Z8G4 Host Computer

- 1.) Install the fiber connector to the OC chassis.



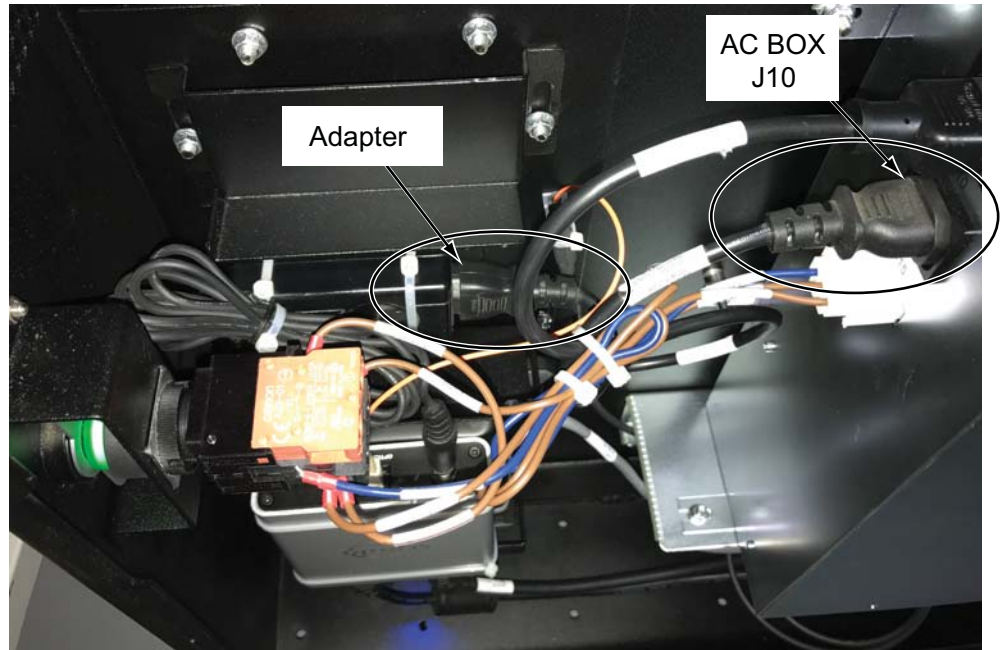
**Figure 2-52 Fiber Connector**

- 2.) Install the adapter and splitter onto the HUB bracket, and use Nylon cable tie to fix them.



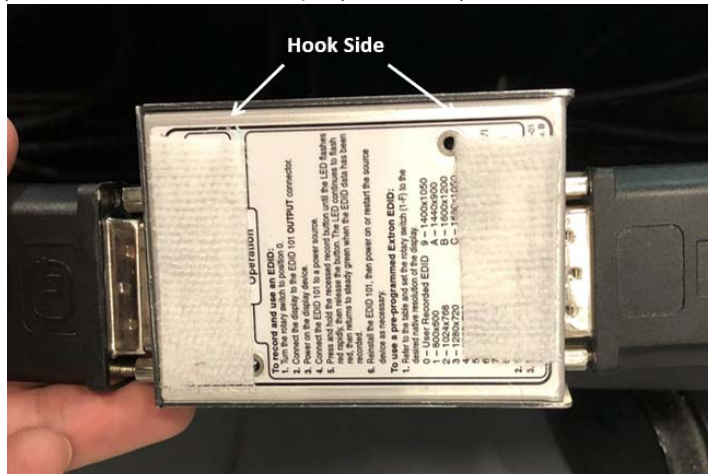
**Figure 2-53 Attach Adapter and Splitter**

- 3.) Connect the power cable (5573802) between the splitter adapter and the AC box outlet **J10 (Z840)** or **J11 (Z8G4)**.



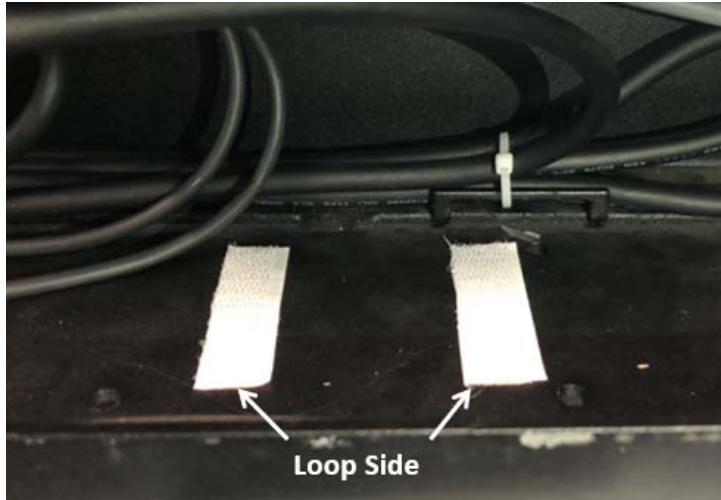
**Figure 2-54 Adapter Power Cable Connection (Example for Z840)**

- 4.) Connect the power cable and optical fiber cable to the splitter.
- NOTICE** If it does not contain **Emulator Kit (5836007)** in purchased **Boom-In-Room Kit (B7710AN)**, please ignore [Step 5](#) to [Step 8](#), skip to [Step 9](#) directly.
- 5.) Adhere the Velcro Strips (hook side) on emulator rear surface.



**Figure 2-55 Velcro Strips on Emulator**

6.) Adhere the Velcro Strips (loop side) on OpenOC chassis bottom surface, under the AC box.



**Figure 2-56 Velcro Strips on OpenOC**

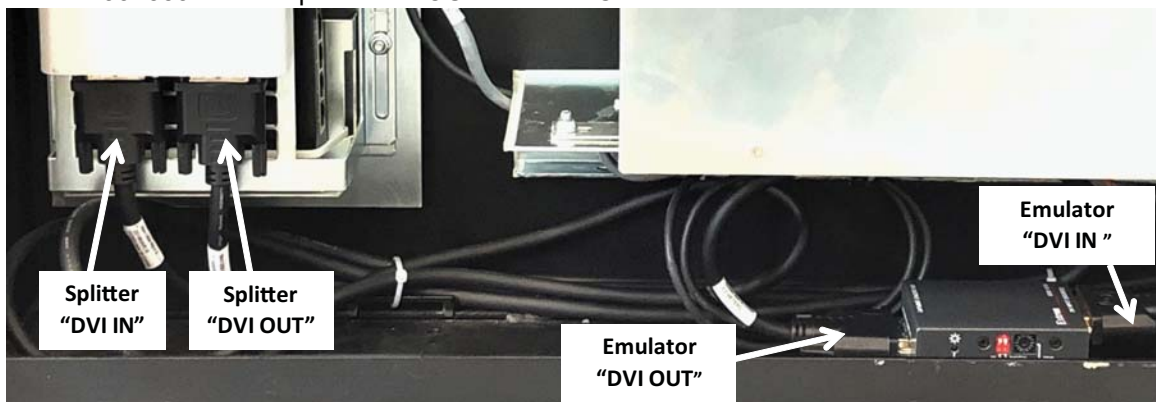
7.) Attach the Velcro loop side and hook side to install the DVI emulator.

8.) Connect three DVI video cables.

- a.) Connect video splitter "DVI OUT" and local LCD monitor by 5m DVI-D to DVI-D cable (5548852).
- b.) Connect video splitter "DVI IN" port and emulator "DVI OUT" port by 0.35m DVI-D to DVI-D cable (5641358-3).
- c.) Connect emulator "DVI IN" and Host PC by DP to DVI cable (5641358/5408703-2).

Note:

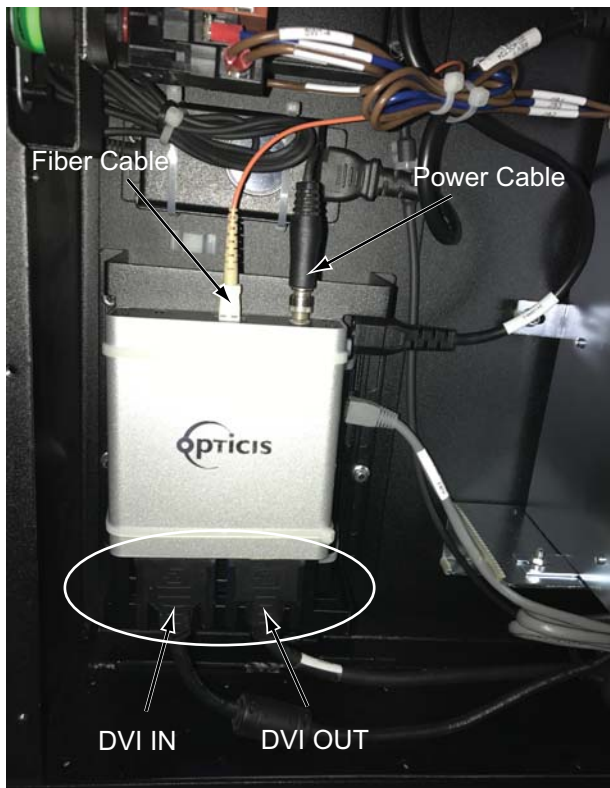
- for Z840 Host Computer
  - 5641358: from Host PC DVI to Splitter DVI-IN
  - 5548852: from Splitter DVI-OUT to local LCD monitor
- for Z8G4 Host Computer
  - 5408703-2: from Host PC DP to Splitter DVI-I
  - 5548852: from Splitter DVI-OUT to local LCD monitor



**Figure 2-57 DVI Video Cable Connection (With Emulator)**

- 9.) Connect two DVI video cables.
  - a.) Connect video splitter "DVI OUT" and local LCD monitor by 5m DVI-D to DVI-D cable (5548852).
  - b.) Connect video splitter "DVI IN" and Host PC by DP to DVI cable (5641358/5408703-2).

- Note:
- for Z840 Host Computer
    - 5641358: from Host PC DVI to Splitter DVI-IN
    - 5548852: from Splitter DVI-OUT to local LCD monitor
  - for Z8G4 Host Computer
    - 5408703-2: from Host PC DP to Splitter DVI-I
    - 5548852: from Splitter DVI-OUT to local LCD monitor

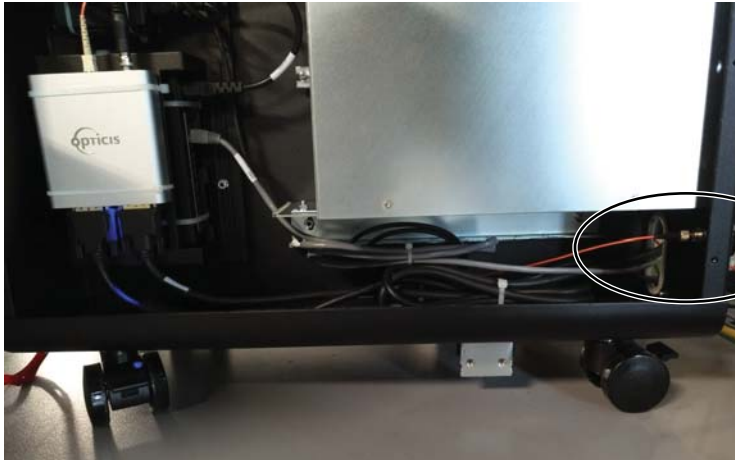


**Figure 2-58 DVI Video Cable Connection (Without Emulator)**

10.) Route and connect the optical fiber cable.



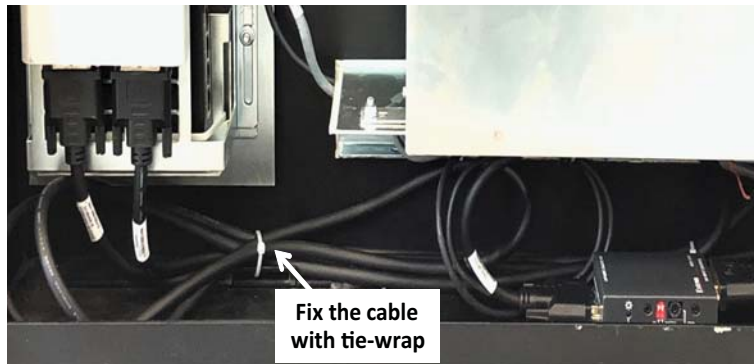
Fix the Fiber Cable  
by Using Tie-wrap



**Figure 2-59 Fiber Cable Connection**

11.) Route and connect video cables.

With Emulator



Without Emulator

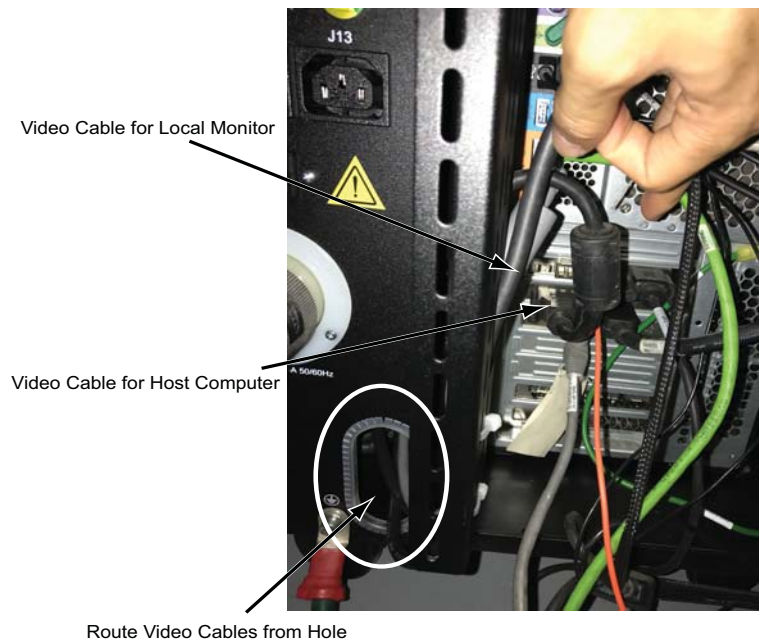
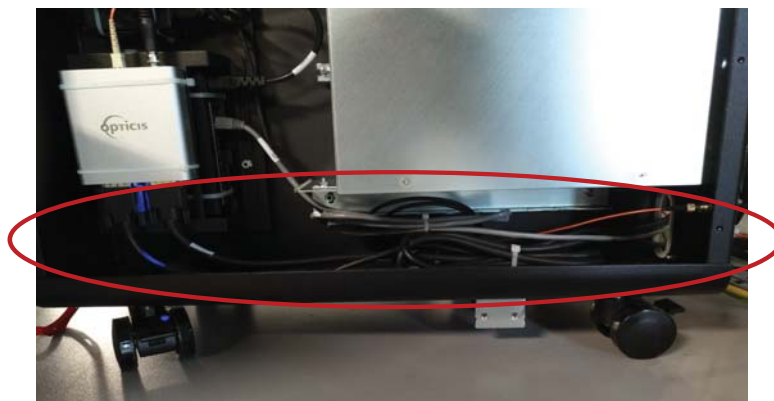
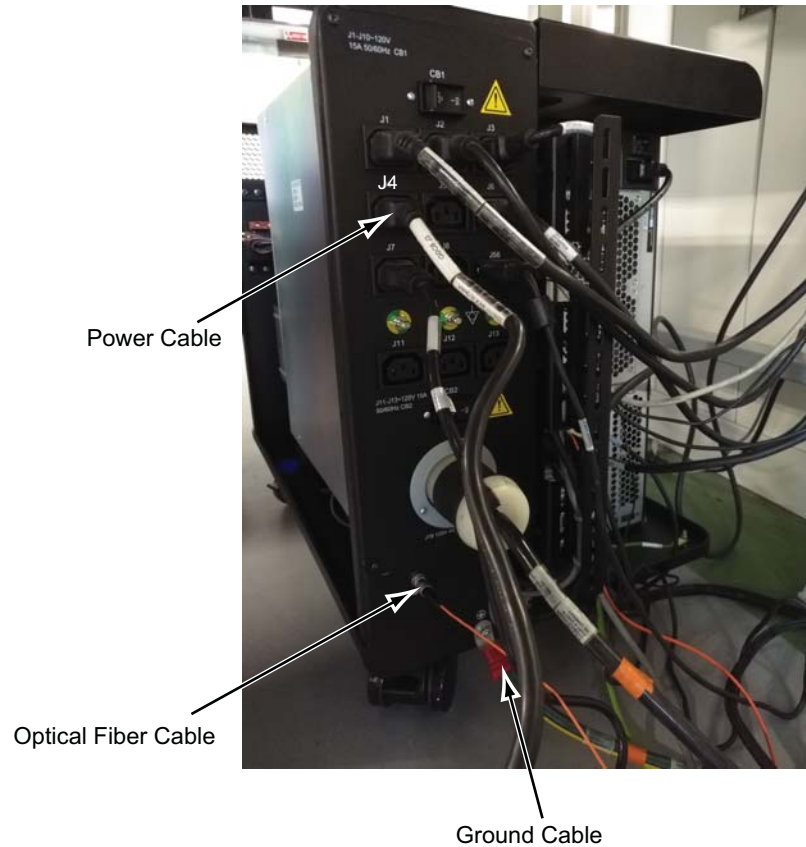


Figure 2-60 Video Cable Connection

- 12.) Connect three cables (power cable, optical fiber and ground cable) of the boom-in-room assembly routed in [6.3 Junction Box Cover Plate Assembly Installation, Step 4](#) to console.
- Power cable to AC box J4 (Z840) or J7 (Z8G4)
  - Optical fiber to OC chassis connector
  - Ground cable to OC chassis



**Figure 2-61 Boom-In-Room Cable Connections**

### 10.3 StandAlone Console with Z8G4 Host Computer

**NOTICE** The power box (B76282DA) need to be ordered before the splitter installation for StandAlone Console, because the splitter will be installed into the power box.

- 1.) Remove the power box rear cover by unscrewing 4 screws.

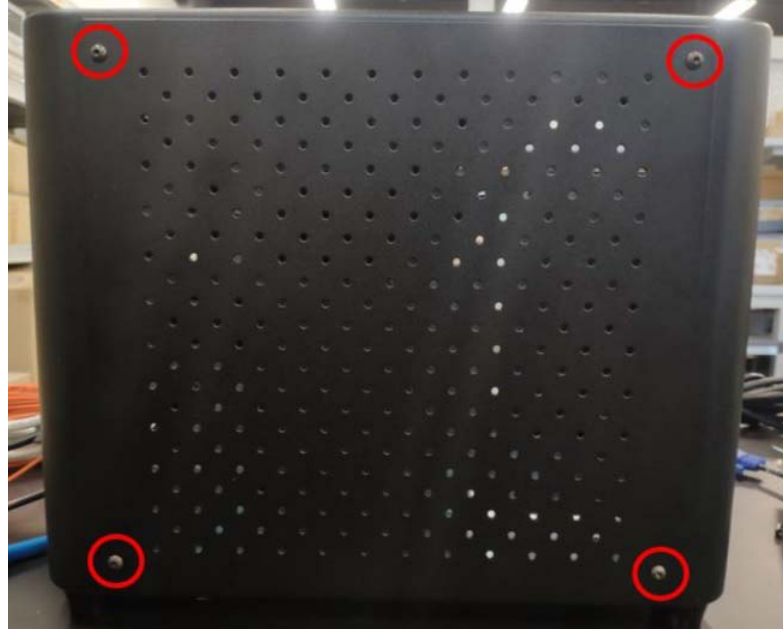


Figure 2-62 Power Box Rear Cover

- 2.) Mount the splitter onto the bracket and mount the adapter onto the rear side of the bracket by using VELCRO LOOP/HOOKS, and use Nylon cable tie to fix them.

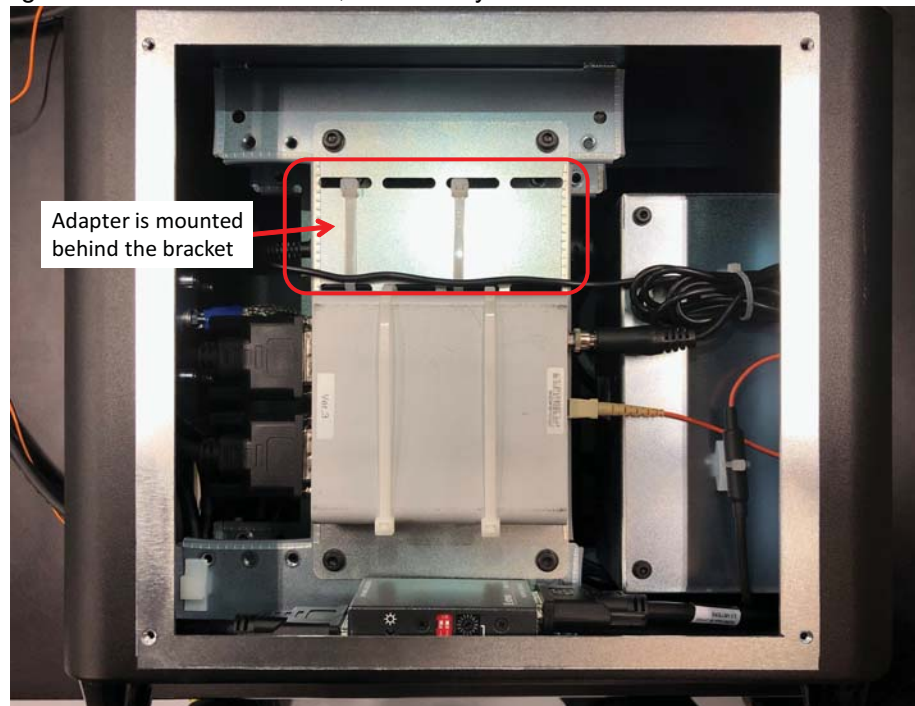


Figure 2-63 Splitter and Adapter Position

- 3.) Connect the power cable (5573802) between the adapter and the power box outlet J5. (See [Figure 2-63](#) and [Figure 2-64](#))

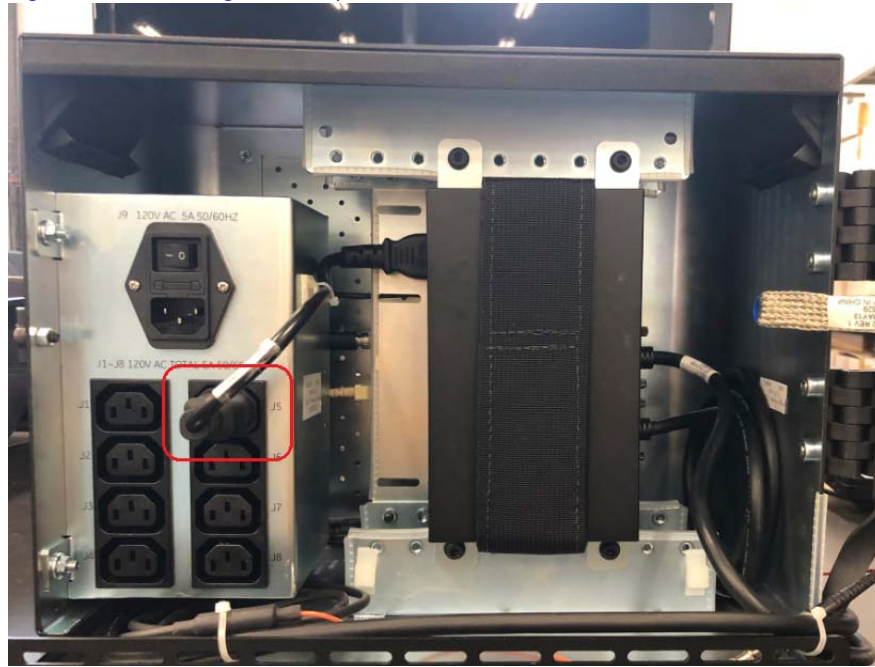


Figure 2-64 Power Box Outlet

- 4.) Connect the power cable and optical fiber cable to the splitter.

**NOTICE** If it does not contain Emulator Kit (5836007) in purchased Boom-In-Room Kit (B7710AN), please ignore [Step 5](#) to [Step 7](#), skip to [Step 8](#) directly.

- 5.) Adhere the Velcro Strips (hook side) on emulator rear surface.

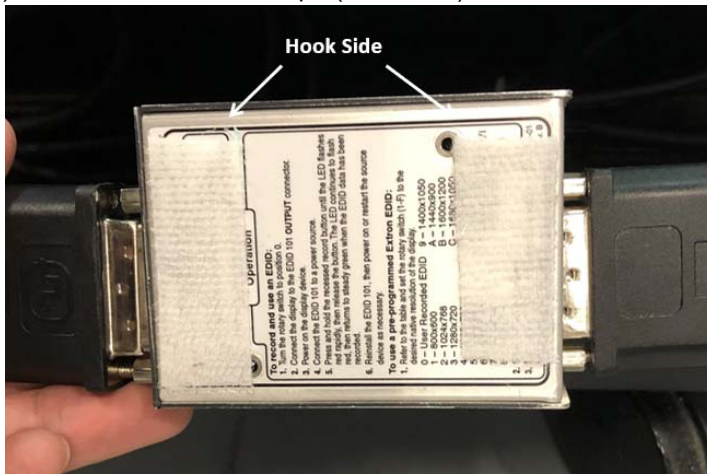


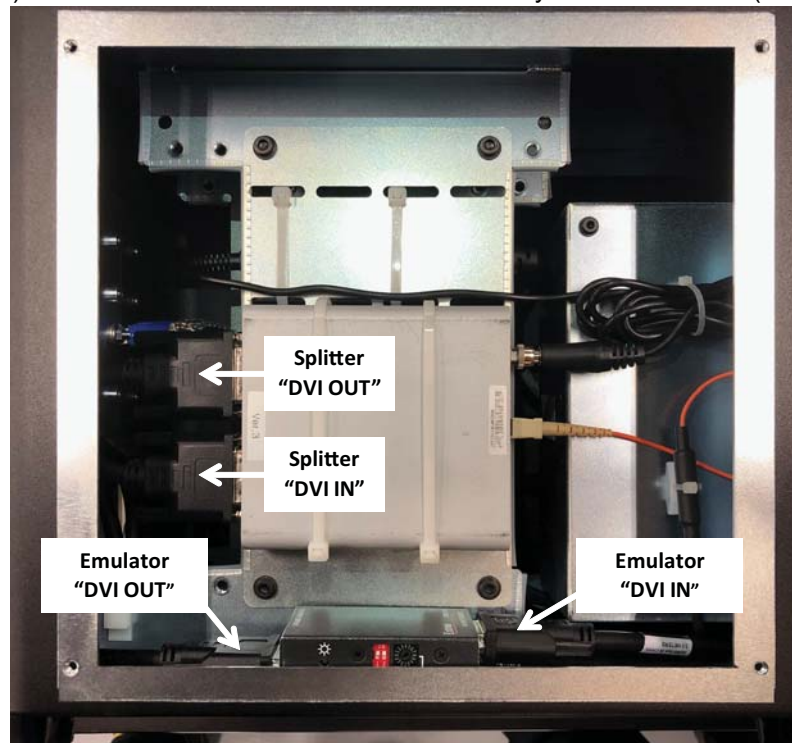
Figure 2-65 Velcro Strips on Emulator

- 6.) Adhere the Velcro Strips (loop side) on power box bottom surface, under splitter bracket.



**Figure 2-66 Install Emulator**

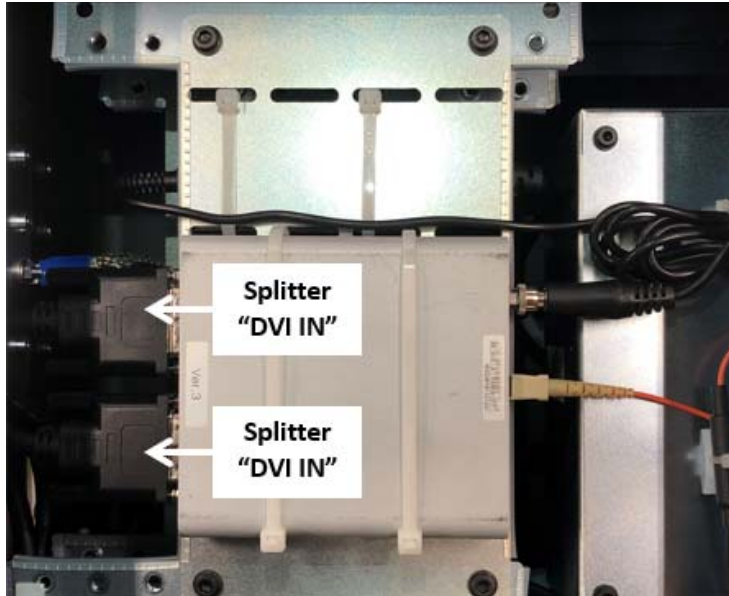
- 7.) Connect three DVI video cables.
- a.) Connect video splitter "DVI OUT" and local LCD monitor by 5m DVI-D to DVI-D cable (5548852).
  - b.) Connect video splitter "DVI IN" port and emulator "DVI OUT" port by 0.35m DVI-D to DVI-D cable (5641358-3).
  - c.) Connect emulator "DVI IN" and Host PC by DP to DVI cable (5408703-2).



**Figure 2-67 DVI Video Cable Connection (With Emulator)**

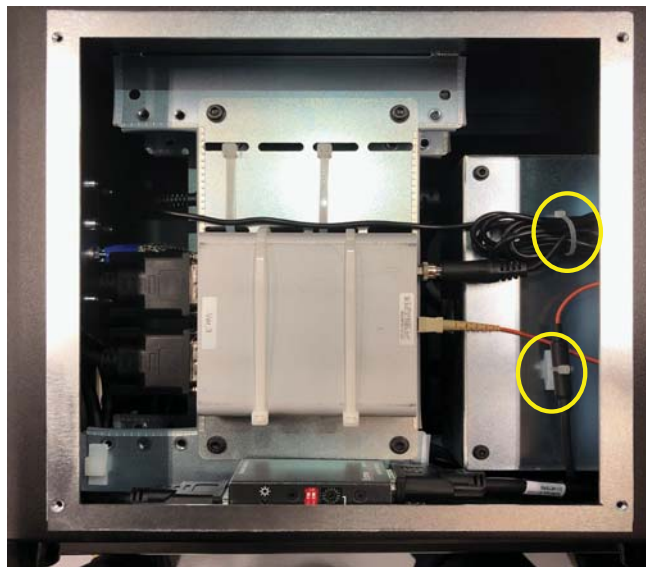
- 8.) Connect two DVI video cables.
- a.) Connect video splitter "DVI OUT" and local LCD monitor by 5m DVI-D to DVI-D cable (5548852).

b.) Connect video splitter "DVI IN" and Host PC by DP to DVI cable (5408703-2).



**Figure 2-68 DVI Video Cable Connection (Without Emulator)**

9.) Route all DVI video cables and the optical fiber as below figures shown.  
Rear Side



Front Side



**Figure 2-69 Route DVI Video Cables and Optical Fiber**

- 10.) Connect three cables (power cable, optical fiber and ground cable) of the boom-in-room assembly routed in [6.3 Junction Box Cover Plate Assembly Installation](#), [Step 4](#) to console.
  - Power cable to Power Box J5
  - Optical fiber to Power Box connector
  - Ground cable to Power Box

## Section 11.0 Finalization

### 11.1 Restore System Power

- 1.) Check all electrical connections.
- 2.) Remove LOTO.
- 3.) Turn ON power to the system.

#### WARNING



**POSSIBLE ACCIDENTAL SHOCK TO PATIENTS.**

**INCORRECTLY-POWERED AND GROUNDED WIRING CAN CAUSE ELECTROCUTION, SERIOUS INJURY OR DEATH.**

**CAREFULLY CHECK ALL GROUND CONNECTIONS, THEN PERFORM THE LEAKAGE/ GROUND CURRENT TEST PROCEDURE IN THE FOLLOWING SECTION.**

### 11.2 Adjust Monitor Contrast/Brightness

Use the LCD Monitor Setup procedure found in Service Methods of your system and refer to *Service Method -> Align, Setup, Cals -> Console* for setup instructions.

Note: Customers can choose to purchase DIN6868-157 LCD Monitor Option Kit (B75052CC) if they use their CT system for the primary diagnostic image review by the radiologist. Please refer DIN Monitor Option Installation Manual (5798612-1EN) for detailed installation and setting which in kit (B75052CC).

## Section 12.0 Patient Touch Leakage Test and Ground Resistance Check

Refer to the System Service Methods CD to locate the latest Enclosure Leakage (Patient Touch) and System Chassis Leakage Tests under the **Functional Check** chapter.

---

*This page intentionally left blank.*



[www.gehealthcare.com](http://www.gehealthcare.com)

