

GE Healthcare

Optima CT540 Gantry Rear Control Panel Installation Manual

OPERATING DOCUMENTATION



5441082-1EN

Rev 1

© 2012 General Electric Company.

All rights reserved.

LEGAL NOTES

TRADEMARKS

Adobe, the Adobe logo, Acrobat, the Acrobat logo, Exchange, and PostScript are trademarks of Adobe Systems Incorporated or its subsidiaries and may be registered in certain jurisdictions.

Microsoft is a registered trademark and Windows is a trademark of Microsoft Corporation.

All other products and their name brands are trademarks of their respective holders.

COPYRIGHTS

All Material Copyrighted (c) 2012 by the GE Company, All rights reserved.

IMPORTANT PRECAUTIONS

LANGUAGE

<p>ПРЕДУПРЕЖДЕНИЕ (BG)</p>	<p>Това упътване за работа е налично само на английски език.</p> <ul style="list-style-type: none"> • Ако доставчикът на услугата на клиента изиска друг език, задължение на клиента е да осигури превод. • Не използвайте оборудването, преди да сте се консултирали и разбрали упътването за работа. • Неспазването на това предупреждение може да доведе до нараняване на доставчика на услугата, оператора или пациента в резултат на токов удар, механична или друга опасност.
<p>警告 (ZH-CN)</p>	<p>本维修手册仅提供英文版本。</p> <ul style="list-style-type: none"> • 如果维修服务提供商需要非英文版本，客户需自行提供翻译服务。 • 未详细阅读和完全理解本维修手册之前，不得进行维修。 • 忽略本警告可能对维修人员，操作员或患者造成触电、机械伤害或其他形式的伤害。
<p>警告 (ZH-HK)</p>	<p>本服務手冊僅提供英文版本。</p> <ul style="list-style-type: none"> • 倘若客戶的服務供應商需要英文以外之服務手冊，客戶有責任提供翻譯服務。 • 除非已參閱本服務手冊及明白其內容，否則切勿嘗試維修設備。 • 不遵從本警告或會令服務供應商、網絡供應商或病人受到觸電、機械性或其他危險。
<p>警告 (ZH-TW)</p>	<p>本維修手冊僅有英文版。</p> <ul style="list-style-type: none"> • 若客戶的維修廠商需要英文版以外的語言，應由客戶自行提供翻譯服務。 • 請勿試圖維修本設備，除非 您已查閱並瞭解本維修手冊。 • 若未留意本警告，可能導致維修廠商、操作員或病患因觸電、機械或其他危險而受傷。
<p>UPOZORENJE (HR)</p>	<p>Ovaj servisni priručnik dostupan je na engleskom jeziku.</p> <ul style="list-style-type: none"> • Ako davatelj usluge klijenta treba neki drugi jezik, klijent je dužan osigurati prijevod. • Ne pokušavajte servisirati opremu ako niste u potpunosti pročitali i razumjeli ovaj servisni priručnik. • Zanimarite li ovo upozorenje, može doći do ozljede davatelja usluge, operatera ili pacijenta uslijed strujnog udara, mehaničkih ili drugih rizika.
<p>VÝSTRAHA (CS)</p>	<p>Tento provozní návod existuje pouze v anglickém jazyce.</p> <ul style="list-style-type: none"> • V případě, že externí služba zákazníkům potřebuje návod v jiném jazyce, je zajištění překladu do odpovídajícího jazyka úkolem zákazníka. • Nesnažte se o údržbu tohoto zařízení, aniž byste si přečetli tento provozní návod a pochopili jeho obsah. • V případě nedodržování této výstrahy může dojít k poranění pracovníka prodejního servisu, obslužného personálu nebo pacientů vlivem elektrického proudu, respektive vlivem mechanických či jiných rizik.

ADVARSEL (DA)	<p>Denne servicemanual findes kun på engelsk.</p> <ul style="list-style-type: none">• Hvis en kundes tekniker har brug for et andet sprog end engelsk, er det kundens ansvar at sørge for oversættelse.• Forsøg ikke at servicere udstyret uden at læse og forstå denne servicemanual.• Manglende overholdelse af denne advarsel kan medføre skade på grund af elektrisk stød, mekanisk eller anden fare for teknikeren, operatøren eller patienten.
WAARSCHUWING (NL)	<p>Deze onderhoudshandleiding is enkel in het Engels verkrijgbaar.</p> <ul style="list-style-type: none">• Als het onderhoudspersoneel een andere taal vereist, dan is de klant verantwoordelijk voor de vertaling ervan.• Probeer de apparatuur niet te onderhouden alvorens deze onderhoudshandleiding werd geraadpleegd en begrepen is.• Indien deze waarschuwing niet wordt opgevolgd, zou het onderhoudspersoneel, de operator of een patiënt gewond kunnen raken als gevolg van een elektrische schok, mechanische of andere gevaren.
WARNING (EN)	<p>This service manual is available in English only.</p> <ul style="list-style-type: none">• If a customer's service provider requires a language other than English, it is the customer's responsibility to provide translation services.• Do not attempt to service the equipment unless this service manual has been consulted and is understood.• Failure to heed this warning may result in injury to the service provider, operator or patient from electric shock, mechanical or other hazards.
HOIATUS (ET)	<p>See teenindusjuhend on saadaval ainult inglise keeles.</p> <ul style="list-style-type: none">• Kui klienditeeninduse osutaja nõuab juhendit inglise keelest erinevas keeles, vastutab klient tõlketeenuse osutamise eest.• Ärge üritage seadmeid teenindada enne eelnevalt käesoleva teenindusjuhendiga tutvumist ja sellest aru saamist.• Käesoleva hoiatuse eiramine võib põhjustada teenuseosutaja, operaatori või patsiendi vigastamist elektrilöögi, mehaanilise või muu ohu tagajärjel.
VAROITUS (FI)	<p>Tämä huolto-ohje on saatavilla vain englanniksi.</p> <ul style="list-style-type: none">• Jos asiakkaan huoltohenkilöstö vaatii muuta kuin englanninkielistä materiaalia, tarvittavan käännöksen hankkiminen on asiakkaan vastuulla.• Älä yritä korjata laitteistoa ennen kuin olet varmasti lukenut ja ymmärtänyt tämän huolto-ohjeen.• Mikäli tätä varoitusta ei noudateta, seurauksena voi olla huoltohenkilöstön, laitteiston käyttäjän tai potilaan vahingoittuminen sähköiskun, mekaanisen vian tai muun vaaratilanteen vuoksi.
ATTENTION (FR)	<p>Ce manuel d'installation et de maintenance est disponible uniquement en anglais.</p> <ul style="list-style-type: none">• Si le technicien d'un client a besoin de ce manuel dans une langue autre que l'anglais, il incombe au client de le faire traduire.• Ne pas tenter d'intervenir sur les équipements tant que ce manuel d'installation et de maintenance n'a pas été consulté et compris.• Le non-respect de cet avertissement peut entraîner chez le technicien, l'opérateur ou le patient des blessures dues à des dangers électriques, mécaniques ou autres.

<p>WARNUNG (DE)</p>	<p>Diese Serviceanleitung existiert nur in englischer Sprache.</p> <ul style="list-style-type: none"> • Falls ein fremder Kundendienst eine andere Sprache benötigt, ist es Aufgabe des Kunden für eine entsprechende Übersetzung zu sorgen. • Versuchen Sie nicht diese Anlage zu warten, ohne diese Serviceanleitung gelesen und verstanden zu haben. • Wird diese Warnung nicht beachtet, so kann es zu Verletzungen des Kundendiensttechnikers, des Bedieners oder des Patienten durch Stromschläge, mechanische oder sonstige Gefahren kommen.
<p>ΠΡΟΕΙΔΟΠΟΙΗΣΗ (EL)</p>	<p>Το παρόν εγχειρίδιο σέρβις διατίθεται μόνο στα αγγλικά.</p> <ul style="list-style-type: none"> • Εάν ο τεχνικός σέρβις ενός πελάτη απαιτεί το παρόν εγχειρίδιο σε γλώσσα εκτός των αγγλικών, αποτελεί ευθύνη του πελάτη να παρέχει τις υπηρεσίες μετάφρασης. • Μην επιχειρήσετε την εκτέλεση εργασιών σέρβις στον εξοπλισμό αν δεν έχετε συμβουλευτεί και κατανοήσει το παρόν εγχειρίδιο σέρβις. • Αν δεν προσέξετε την προειδοποίηση αυτή, ενδέχεται να προκληθεί τραυματισμός στον τεχνικό σέρβις, στο χειριστή ή στον ασθενή από ηλεκτροπληξία, μηχανικούς ή άλλους κινδύνους.
<p>FIGYELMEZTETÉS (HU)</p>	<p>Ezen karbantartási kézikönyv kizárólag angol nyelven érhető el.</p> <ul style="list-style-type: none"> • Ha a vevő szolgáltatója angoltól eltérő nyelvre tart igényt, akkor a vevő felelőssége a fordítás elkészítése. • Ne próbálja elkezdni használni a berendezést, amíg a karbantartási kézikönyvben leírtakat nem értelmezték. • Ezen figyelmeztetés figyelmen kívül hagyása a szolgáltató, működtető vagy a beteg áramütés, mechanikai vagy egyéb veszélyhelyzet miatti sérülését eredményezheti.
<p>AÐVÖRUN (IS)</p>	<p>Þessi þjónustuhandbók er aðeins fáanleg á ensku.</p> <ul style="list-style-type: none"> • Ef að þjónustuveitandi viðskiptamanns þarfnast annas tungumáls en ensku, er það skylda viðskiptamanns að skaffa tungumálþjónustu. • Reynið ekki að afgreiða tækið nema að þessi þjónustuhandbók hefur verið skoðuð og skilin. • Brot á sinna þessari aðvörun getur leitt til meiðsla á þjónustuveitanda, stjórnanda eða sjúklings frá raflosti, vélrænu eða öðrum áhættum.
<p>AVVERTENZA (IT)</p>	<p>Il presente manuale di manutenzione è disponibile soltanto in lingua inglese.</p> <ul style="list-style-type: none"> • Se un addetto alla manutenzione richiede il manuale in una lingua diversa, il cliente è tenuto a provvedere direttamente alla traduzione. • Procedere alla manutenzione dell'apparecchiatura solo dopo aver consultato il presente manuale ed averne compreso il contenuto. • Il mancato rispetto della presente avvertenza potrebbe causare lesioni all'addetto alla manutenzione, all'operatore o ai pazienti provocate da scosse elettriche, urti meccanici o altri rischi.
<p>警告 (JA)</p>	<p>このサービスマニュアルには英語版しかありません。</p> <ul style="list-style-type: none"> • サービスを担当される業者が英語以外の言語を要求される場合、翻訳作業はその業者の責任で行うものとさせていただきます。 • このサービスマニュアルを熟読し理解せずに、装置のサービスを行わないでください。 • この警告に従わない場合、サービスを担当される方、操作員あるいは患者さんが、感電や機械的又はその他の危険により負傷する可能性があります。

<p>경고 (KO)</p>	<p>본 서비스 매뉴얼은 영어로만 이용하실 수 있습니다.</p> <ul style="list-style-type: none"> • 고객의 서비스 제공자가 영어 이외의 언어를 요구할 경우, 번역 서비스를 제공하는 것은 고객의 책임입니다. • 본 서비스 매뉴얼을 참조하여 숙지하지 않은 이상 해당 장비를 수리하려고 시도하지 마십시오. • 본 경고 사항에 유의하지 않으면 전기 쇼크, 기계적 위험, 또는 기타 위험으로 인해 서비스 제공자, 사용자 또는 환자에게 부상을 입힐 수 있습니다.
<p>BRĪDINĀJUMS (LV)</p>	<p>Šī apkopes rokasgrāmata ir pieejama tikai angļu valodā.</p> <ul style="list-style-type: none"> • Ja klienta apkopes sniedzējam nepieciešama informācija citā valodā, klienta pienākums ir nodrošināt tulkojumu. • Neveiciet aprīkojuma apkopi bez apkopes rokasgrāmatas izlasīšanas un saprašanas. • Šī brīdinājuma neievērošanas rezultātā var rasties elektriskās strāvas trieciena, mehānisku vai citu faktoru izraisītu traumu risks apkopes sniedzējam, operatoram vai pacientam.
<p>ĮSPĖJIMAS (LT)</p>	<p>Šis eksploatavimo vadovas yra tik anglų kalba.</p> <ul style="list-style-type: none"> • Jei kliento paslaugų tiekėjas reikalauja vadovo kita kalba – ne anglų, suteikti vertimo paslaugas privalo klientas. • Nemėginkite atlikti įrangos techninės priežiūros, jei neperskaitėte ar nesupratote šio eksploatavimo vadovo. • Jei nepaisysite šio įspėjimo, galimi paslaugų tiekėjo, operatoriaus ar paciento sužalojimai dėl elektros šoko, mechaninių ar kitų pavojų.
<p>ADVARSEL (NO)</p>	<p>Denne servicehåndboken finnes bare på engelsk.</p> <ul style="list-style-type: none"> • Hvis kundens serviceleverandør har bruk for et annet språk, er det kundens ansvar å sørge for oversettelse. • Ikke forsøk å reparere utstyret uten at denne servicehåndboken er lest og forstått. • Manglende hensyn til denne advarselen kan føre til at serviceleverandøren, operatøren eller pasienten skades på grunn av elektrisk støt, mekaniske eller andre farer.
<p>OSTRZEŻENIE (PL)</p>	<p>Niniejszy podręcznik serwisowy dostępny jest jedynie w języku angielskim.</p> <ul style="list-style-type: none"> • Jeśli serwisant klienta wymaga języka innego niż angielski, zapewnienie usługi tłumaczenia jest obowiązkiem klienta. • Nie próbować serwisować urządzenia bez zapoznania się z niniejszym podręcznikiem serwisowym i zrozumienia go. • Niezastosowanie się do tego ostrzeżenia może doprowadzić do obrażeń serwisanta, operatora lub pacjenta w wyniku porażenia prądem elektrycznym, zagrożenia mechanicznego bądź innego.
<p>ATENÇÃO (PT-BR)</p>	<p>Este manual de assistência técnica encontra-se disponível unicamente em inglês.</p> <ul style="list-style-type: none"> • Se outro serviço de assistência técnica solicitar a tradução deste manual, caberá ao cliente fornecer os serviços de tradução. • Não tente reparar o equipamento sem ter consultado e compreendido este manual de assistência técnica. • A não observância deste aviso pode ocasionar ferimentos no técnico, operador ou paciente decorrentes de choques elétricos, mecânicos ou outros.

ATENÇÃO (PT-PT)	<p>Este manual de assistência técnica só se encontra disponível em inglês.</p> <ul style="list-style-type: none">• Se qualquer outro serviço de assistência técnica solicitar este manual noutra língua, é da responsabilidade do cliente fornecer os serviços de tradução.• Não tente reparar o equipamento sem ter consultado e compreendido este manual de assistência técnica.• O não cumprimento deste aviso pode colocar em perigo a segurança do técnico, do operador ou do paciente devido a choques eléctricos, mecânicos ou outros.
ATENȚIE (RO)	<p>Acest manual de service este disponibil doar în limba engleză.</p> <ul style="list-style-type: none">• Dacă un furnizor de servicii pentru clienți necesită o altă limbă decât cea engleză, este de datoria clientului să furnizeze o traducere.• Nu încercați să reparați echipamentul decât ulterior consultării și înțelegerii acestui manual de service.• Ignorarea acestui avertisment ar putea duce la rănirea depanatorului, operatorului sau pacientului în urma pericolelor de electrocutare, mecanice sau de altă natură.
ОСТОРОЖНО! (RU)	<p>Данное руководство по техническому обслуживанию представлено только на английском языке.</p> <ul style="list-style-type: none">• Если сервисному персоналу клиента необходимо руководство не на английском, а на каком-то другом языке, клиенту следует самостоятельно обеспечить перевод.• Перед техническим обслуживанием оборудования обязательно обратитесь к данному руководству и поймите изложенные в нем сведения.• Несоблюдение требований данного предупреждения может привести к тому, что специалист по техобслуживанию, оператор или пациент получит удар электрическим током, механическую травму или другое повреждение.
UPOZORENJE (SR)	<p>Ovo servisno uputstvo je dostupno samo na engleskom jeziku.</p> <ul style="list-style-type: none">• Ako klijentov serviser zahteva neki drugi jezik, klijent je dužan da obezbedi prevodilačke usluge.• Ne pokušavajte da opravite uređaj ako niste pročitali i razumeli ovo servisno uputstvo.• Ne pokušavajte da opravite uređaj ako niste pročitali i razumeli ovo servisno uputstvo.
UPOZORNENIE (SK)	<p>Tento návod na obsluhu je k dispozícii len v angličtine.</p> <ul style="list-style-type: none">• Ak zákazníkovi poskytovateľ služieb vyžaduje iný jazyk ako angličtinu, poskytnutie prekladateľských služieb je zodpovednosťou zákazníka.• Nepokúšajte sa o obsluhu zariadenia, kým si neprečítate návod na obsluhu a neporozumiete mu.• Zanedbanie tohto upozornenia môže spôsobiť zranenie poskytovateľa služieb, obsluhujúcej osoby alebo pacienta elektrickým prúdom, mechanické alebo iné ohrozenie.

ATENCIÓN (ES)	<p>Este manual de servicio sólo existe en inglés.</p> <ul style="list-style-type: none">• Si el encargado de mantenimiento de un cliente necesita un idioma que no sea el inglés, el cliente deberá encargarse de la traducción del manual.• No se deberá dar servicio técnico al equipo, sin haber consultado y comprendido este manual de servicio.• La no observancia del presente aviso puede dar lugar a que el proveedor de servicios, el operador o el paciente sufran lesiones provocadas por causas eléctricas, mecánicas o de otra naturaleza.
VARNING (SV)	<p>Den här servicehandboken finns bara tillgänglig på engelska.</p> <ul style="list-style-type: none">• Om en kunds servicetekniker har behov av ett annat språk än engelska, ansvarar kunden för att tillhandahålla översättningstjänster.• Försök inte utföra service på utrustningen om du inte har läst och förstår den här servicehandboken.• Om du inte tar hänsyn till den här varningen kan det resultera i skador på serviceteknikern, operatören eller patienten till följd av elektriska stötar, mekaniska faror eller andra faror.
OPOZORILO (SL)	<p>Ta servisni priročnik je na voljo samo v angleškem jeziku.</p> <ul style="list-style-type: none">• Če ponudnik storitve stranke potrebuje priročnik v drugem jeziku, mora stranka zagotoviti prevod.• Ne poskušajte servisirati opreme, če tega priročnika niste v celoti prebrali in razumeli.• Če tega opozorila ne upoštevate, se lahko zaradi električnega udara, mehanskih ali drugih nevarnosti poškoduje ponudnik storitev, operater ali bolnik.
DİKKAT (TR)	<p>Bu servis kılavuzunun sadece ingilizcesi mevcuttur.</p> <ul style="list-style-type: none">• Eğer müşteri teknisyeni bu kılavuzu ingilizce dışında bir başka lisandan talep ederse, bunu tercüme ettirmek müşteriye düşer.• Servis kılavuzunu okuyup anlamadan ekipmanlara müdahale etmeyiniz.• Bu uyarıya uyulmaması, elektrik, mekanik veya diğer tehlikelerden dolayı teknisyen, operatör veya hastanın yaralanmasına yol açabilir.

DAMAGE IN TRANSPORTATION

All packages should be closely examined at time of delivery. If damage is apparent, have notation "damage in shipment" written on all copies of the freight or express bill before delivery is accepted or "signed for" by a General Electric representative or a hospital receiving agent. Whether noted or concealed, damage MUST be reported to the carrier immediately upon discovery, or in any event, within 14 days after receipt, and the contents and containers held for inspection by the carrier. A transportation company will not pay a claim for damage if an inspection is not requested within this 14 day period.

To file a report:

- Call 1-800-548-3366 and use option 8.
- Fill out a report on <http://us44hdd21/sctq/InstallFulfill/InstalFulfillment.htm>
- Contact your local service coordinator for more information on this process.

Rev. Jan. 5, 2005

CERTIFIED ELECTRICAL CONTRACTOR STATEMENT

All electrical Installations that are preliminary to positioning of the equipment at the site prepared for the equipment shall be performed by licensed electrical contractors. In addition, electrical feeds into the Power Distribution Unit shall be performed by licensed electrical contractors. Other connections between pieces of electrical equipment, calibrations and testing shall be performed by qualified GE Medical personnel. The products involved (and the accompanying electrical installations) are highly sophisticated, and special engineering competence is required. In performing all electrical work on these products, GE will use its own specially trained field engineers. All of GE's electrical work on these products will comply with the requirements of the applicable electrical codes.

The purchaser of GE equipment shall only utilize qualified personnel (i.e., GE's field engineers, personnel of third-party service companies with equivalent training, or licensed electricians) to perform electrical servicing on the equipment.

IMPORTANT...X-RAY PROTECTION

X-ray equipment if not properly used may cause injury. Accordingly, the instructions herein contained should be thoroughly read and understood by everyone who will use the equipment before you attempt to place this equipment in operation. The General Electric Company, Medical Systems Group, will be glad to assist and cooperate in placing this equipment in use.

Although this apparatus incorporates a high degree of protection against x-radiation other than the useful beam, no practical design of equipment can provide complete protection. Nor can any practical design compel the operator to take adequate precautions to prevent the possibility of any persons carelessly exposing themselves or others to radiation.

It is important that anyone having anything to do with x-radiation be properly trained and fully acquainted with the recommendations of the National Council on Radiation Protection and Measurements as published in NCRP Reports available from NCRP Publications, 7910 Woodmont Avenue, Room 1016, Bethesda, Maryland 20814, and of the International Commission on Radiation Protection, and take adequate steps to protect against injury.

The equipment is sold with the understanding that the General Electric Company, Medical Systems Group, its agents, and representatives have no responsibility for injury or damage which may result from improper use of the equipment.

Various protective materials and devices are available. It is urged that such materials or devices be used.

LITHIUM BATTERY CAUTIONARY STATEMENTS

CAUTION



Risk of Explosion.

Danger of explosion if battery is incorrectly replaced.

Replace only with the same or equivalent type recommended by the manufacturer. Discard used batteries according to the manufacturer's instructions.

ATTENTION



Danger d'Explosion

Il y a danger d'explosion s'il y a remplacement incorrect de la batterie.

Remplacer uniquement avec une batterie du même type ou d'un type recommandé par le constructeur. Mettre au rebut les batteries usagées conformément aux instructions du fabricant.

OMISSIONS & ERRORS

Customers, please contact your GE Sales or Service representatives.

GE personnel, please use the Healthcare PQR Process to report all omissions, errors, and defects in this publication.

Revision History

Revision	Date	Reason for change
1	Nov. 19, 2012	Initial Release

Table of Contents

Preface

Publication Conventions 17

Section 1.0

Safety & Hazard Information 17

1.1 Text and Character Representation..... 17

1.2 Graphical Representation 18

Section 2.0

Publication Conventions 19

2.1 General Paragraph and Character Styles..... 19

2.2 Page Layout..... 19

2.3 Computer Screen Output/Input Text Character Styles 20

2.4 Buttons, Switches and Keyboard Inputs (Hard & Soft Keys)..... 20

Chapter 1

Introduction..... 21

Section 1.0

Personnel Requirements 21

Section 2.0

Overview 21

2.1 Flowchart 21

Section 3.0

Preliminary Requirements..... 22

3.1 Tools and Test Equipment..... 22

3.2 Consumables..... 22

3.3 Material List 22

3.4 Safety..... 22

3.5 Required Conditions 22

Chapter 2

Installation Procedure 23

Section 1.0

Preparation 23

Section 2.0

Rear Control Panel Installation 23

Section 3.0

Finalization..... 28

3.1 Sanity Test..... 28

3.2 GIB Maintenance 28

Preface

Publication Conventions

Purpose: Standardize conventions for representing information in a uniform way of communicating information to a reader in a consistent manner. Conventions are used so that the reader can easily recognize the actions or decisions that must be made. There are a number of character and paragraph styles used in this publication to accomplish this task. Please become familiar with them before proceeding forward.

Section 1.0 Safety & Hazard Information

1.1 Text and Character Representation

Within this publication, different paragraph and character styles have been used to indicate potential hazards. Paragraph prefixes, such as hazard, caution, danger and warning, are used to identify important safety information. Text (Hazard) styles are applied to the paragraph contents that is applicable to each specific safety statement. Words describe the type of potential hazard that may be encountered and are placed immediately before the paragraph it modifies. Safety information will normally include:

- Type of potential Hazard
- Nature of potential injury
- Causative condition
- How to avoid or correct the causative condition

EXAMPLES OF HAZARD STATEMENTS USED

It's important that you read and understand hazard statements, and not just ignore them.



**DANGER
SEVERE
PERSONAL
INJURY**

DANGER IS USED WHEN A HAZARD EXISTS WHICH WILL CAUSE SEVERE PERSONAL INJURY OR DEATH IF INSTRUCTIONS ARE IGNORED. THEY CAN INCLUDE:

- **ELECTROCUTION**
- **CRUSHING**
- **RADIATION**



**WARNING
SERIOUS
PERSONAL
INJURY**

WARNING IS USED WHEN A HAZARD EXISTS WHICH COULD OR CAN CAUSE SERIOUS PERSONAL INJURY OR DEATH IF INSTRUCTIONS ARE IGNORED. THEY CAN INCLUDE:

- **POTENTIAL FOR SHOCK**
- **EXPOSED WIRES**
- **FAILURE TO TAG AND LOCKOUT SYSTEM POWER COULD ALLOW FOR UN-COMMANDED MOTION.**

 **CAUTION**
Minor Personal Injury
Caution is used when a hazard exists which can or could cause minor injury to self or others if instructions are ignored. They include for example:

- Loss of critical patient data
- Crush or pinch points
- Sharp objects

 **NOTICE**
Property Damage Only
Notice is used when a hazard is present that can cause property damage but has absolutely no personal injury risk. They can include:

- Disk drive will be destroyed
- Internal mechanical damage, such as to the x-ray tube
- Coasting the rotor through resonance.

1.2 Graphical Representation

Important information will always be preceded by the exclamation point  contained within a triangle, as seen throughout the Preface chapter. In addition to text, several different graphical icons (symbols) may be used to make you aware of specific types of hazards that could possibly cause harm.

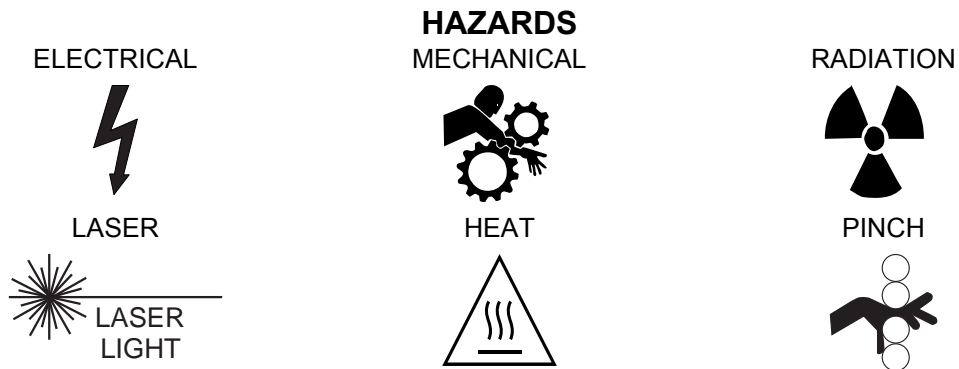

Section 2.0 Publication Conventions

2.1 General Paragraph and Character Styles

Prefixes are used to highlight important non-safety related information. Paragraph prefixes (such as purpose, example, comment or note) are used to identify important but non-safety related information. Text styles are also applied to text within each paragraph modified by the specific prefix.

EXAMPLES OF PREFIXES USED FOR GENERAL INFORMATION

Purpose: Introduces and provides meaning as to the information contained within the chapter, section or subsection, Such as used at the beginning this chapter for example.

Note: Conveys information that should be considered important to the reader.

Example: Used to make the reader aware that the paragraph(s) that follow are examples of information possibly stated previously.

Comment: Represents "additional" information that may or may not be relevant to your situation.

2.2 Page Layout

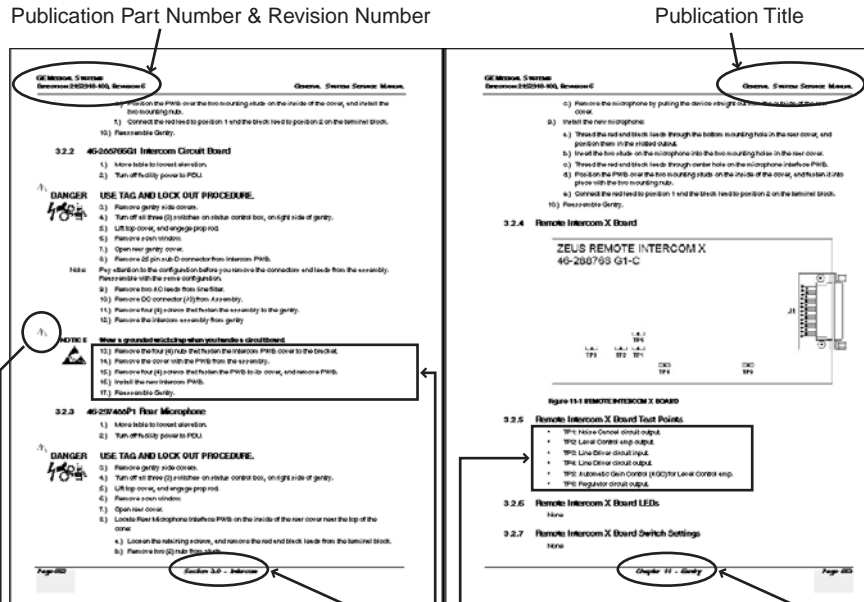

The current section and its title are always shown in the footer of the left (even) page.

An exclamation point in a triangle is used to indicate important information to the user.

Paragraphs preceded by **Alphanumeric** characters (e.g. numbers) contain information that must be followed in a **specific order**.

The current chapter and its title are always shown in the footer of the right (odd) page.

Paragraphs preceded by a **symbol** (e.g. bullets) contain information that has **no specific order**.

Headers and footers in this publication are designed to allow you to quickly identify your location. The document's part number and revision number appears in every header on every page. Odd

numbered page footers indicate the current chapter, its title and current page number. Even page footers show the current section and its title, as well current page number.

2.3 Computer Screen Output/Input Text Character Styles

Within this publication, mono-spaced character styles (fonts) are used to indicate computer text that's either screen input and output. Mono spaced fonts, such as courier, are used to indicate text direction. When you type at your keyboard, you are generating computer input. Occasionally you will see the math operators "greater than" and "less than" symbols used to indicate the start and finish of variable output. When reading text generated by the computer, you are reading it as computer generated output. In addition to direction, characters are italicized (e.g. *italics*) to indicate information specific to your system or site.

Example:
Fixed Output

This paragraph's fonts represents computer generated screen "fixed" output. It's output is fixed from the sense that it does not vary from application to application. It's the most commonly used style used to indicate filenames, paths and text that does not change from system to system. The character style used is a fixed width such as courier.

Example:
Variable Output

This paragraph's font represents computer screen output that is "variable". Its used to represent output that varies from application to application or system to system. Variable output is sometimes found placed between greater than and lesser than operators for clarification. For example: <variable_ouput> or <3.45.120.3>. In both cases, the < and > operators are not part of the actual input.

Example:
Fixed Input

This paragraph's font represents fixed input. It's computer input that is typed-in via the keyboard. Typed input that does not vary from application to application or system to system. Fixed text the user is required to supply as input. For example: cd /usr/3p

Example:
Variable Input

This paragraph's font represents computer input that can vary from application to application or system to system. With variable text, the user is required to supply system dependent input or information. Variable input sometimes is placed between greater-than and less-than operators. For example: <variable_input>. In these cases, the (<>) operators would be dropped prior to input. For example: ypcat hosts | grep <3.45.120.3> would be typed into the computer as ypcat hosts | grep 3.45.120.3 without the greater-than and less-than operators.

2.4 Buttons, Switches and Keyboard Inputs (Hard & Soft Keys)

Different character styles are used to indicate actions requiring the reader to press either a hard or soft button, switch or key. Physical hardware, such as buttons and switches, are called hard keys because they are hard wired or mechanical in nature. A keyboard or on/off switch would be a hard key. Software or computer generated buttons are called soft keys because they are software generated. Software driven menu buttons are an example of such keys. Soft and hard keys are represented differently in this publication.

Example:
Hard Keys

A power switch **ON/OFF** or a keyboard key like **ENTER** is indicated by applying a character style that uses both over and under-lined bold text that is bold. This is a hard key.

Example:
Soft Keys

Whereas the computer MENU button that you would click with your mouse or touch with your hand uses over and under-lined regular text. This is a soft key.

END OF SECTION

Chapter 1

Introduction

Section 1.0 Personnel Requirements

Required Persons	Preliminary Reqs	Procedure	Finalization
1	Timing Not Applicable	1 hours	0 mins

Section 2.0 Overview

This instruction describes the Rear Control Panel installation procedure.

2.1 Flowchart

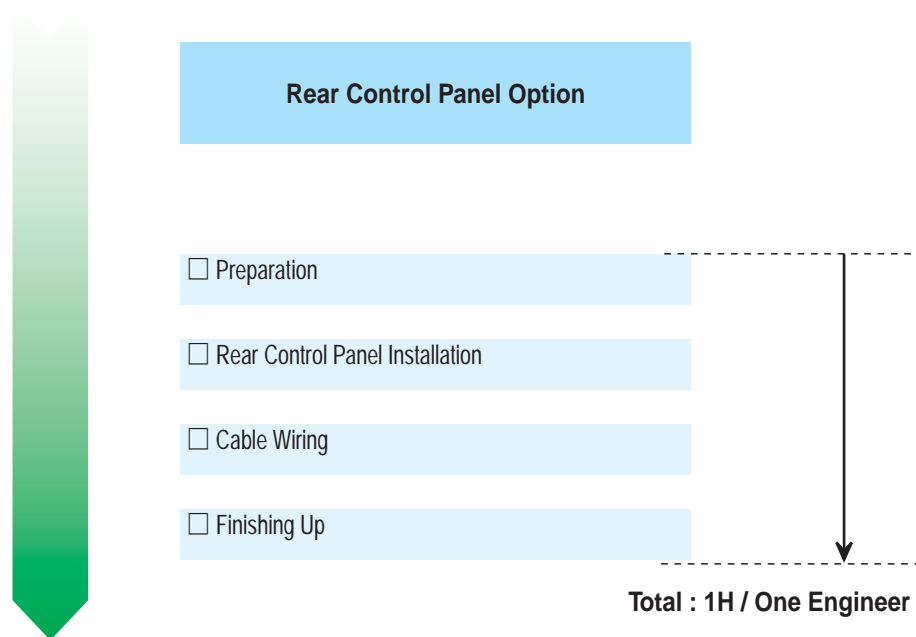

Section 3.0 Preliminary Requirements

3.1 Tools and Test Equipment

None

3.2 Consumables

None

3.3 Material List

Mark	Number	Qty.	Description
1	5332263	1.0	Gantry Control Panel Right Positioning CJ64
2	5332264	1.0	Gantry Control Panel Left Positioning CJ64
3	5408660	1.0	HARNESS ASSY CAN COM TO REAR
4	5408662	1.0	HARNESS ASSY SIGNAL TO REAR COVER
5	5408663	1.0	HARNESS ASSY REAR COVER
6	5408664	1.0	WIRE ASSY GND GCP REAR COVER
7	5408674	1.0	HARNESS ASSY ESTOP TERMINAL
8	U0202AC	20.0	CLAMP CV_150
9	46-221417P1	4.0	FEMALE SCREWLOCKS, TWO PER KIT FOR HD CONNECTORS 4-40 THREAD 0.5 OVERALL LENGTH, YELLOW CHROMATE 0.312 BOTTOM, 0.062 PANEL THK. MAX KIT INCLUDES NUTS AND WASHERS
10	2194456-4	2.0	E-Stop Asm - White N9
11	46-328417P2	10.0	SCREW HEXAGON SOCKET 4 MM 8 MM ZINC PLATED, STEEL
12	46-328432P2	10.0	WASHER LOCK - SPRING 4.1 MM 7.6 MM ZINC PLATED, SPRING STEEL
13	46-328417P73	2.0	SCREW HEXAGON SOCKET 3 MM 6 MM

Table 1-1 Rear Control Panel Option

3.4 Safety

No general safety information.

3.5 Required Conditions

This kit must be installed by GE field engineer.

Chapter 2

Installation Procedure

Section 1.0 Preparation

- 1.) Move the Cradle to OUT limit position.
- 2.) Remove gantry right side cover.
Refer to Parts Replacement -> Gantry -> Enclosure -> (Cover Removal Procedures).
- 3.) Turn OFF the Axial Drive, HVDC and 120 VAC switches on the gantry's Service Switch Panel.
- 4.) Remove the gantry left side cover, top covers and scan window, and slide the rear cover backward.

Section 2.0 Rear Control Panel Installation

- 1.) Remove the gantry rear cover from the rear slide unit using the cover dolly.
Refer to Parts Replacement -> Gantry -> Enclosure -> (Cover Removal Procedures).
- 2.) Remove blind covers of the panel and the e-off button from the rear cover.

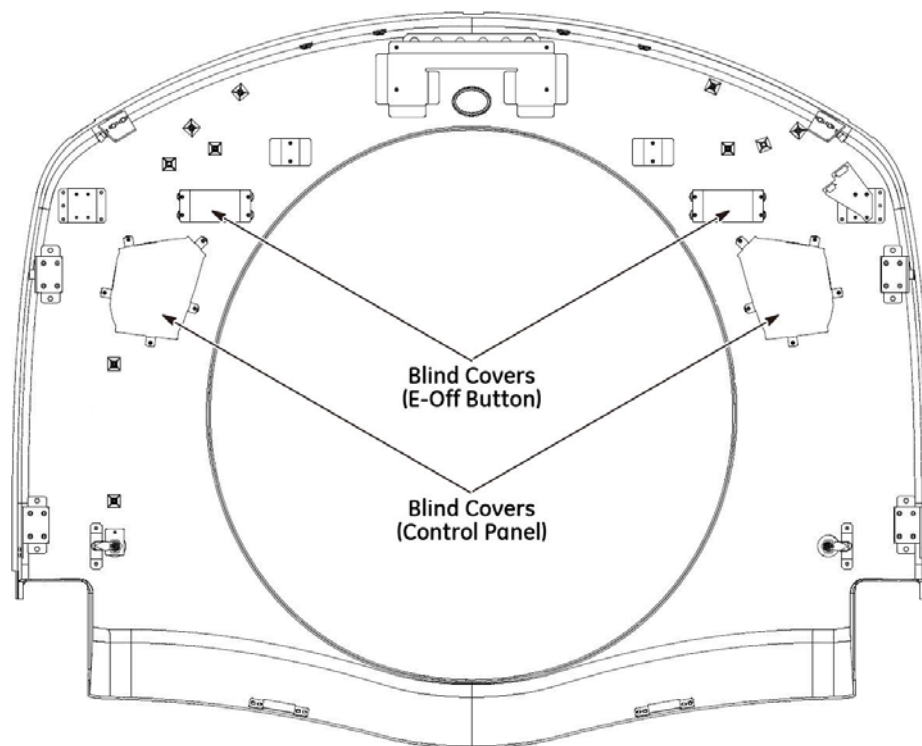

Figure 2-1 Blind Covers on the Gantry Rear Cover

- 3.) Install the control panel (left and right) to the rear cover.

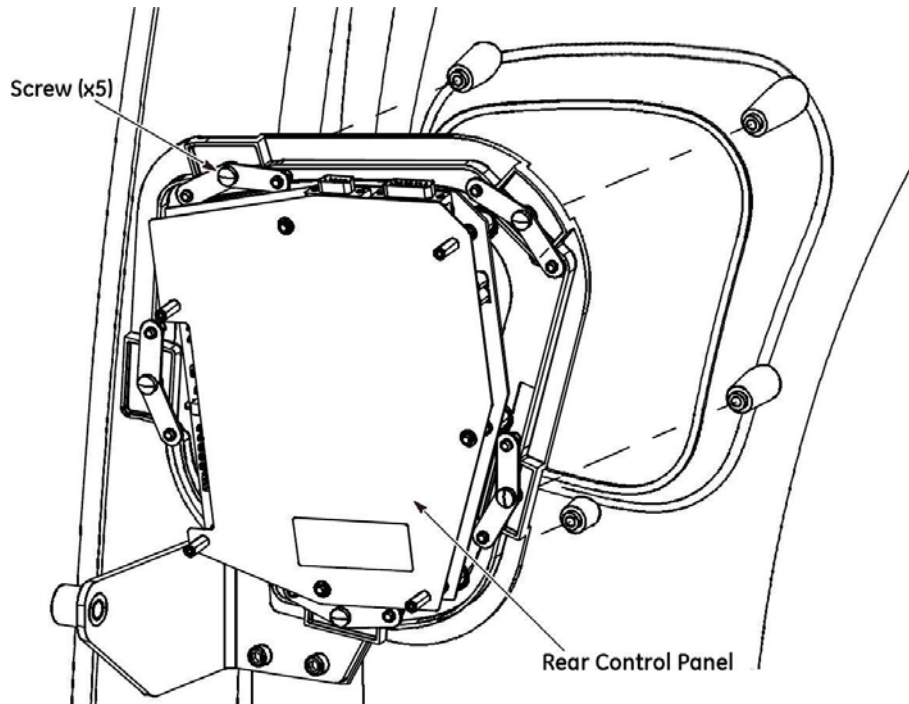

Figure 2-2 Rear Control Panel Installation

- 4.) Install the e-stop assembly (left and right) to the rear cover.

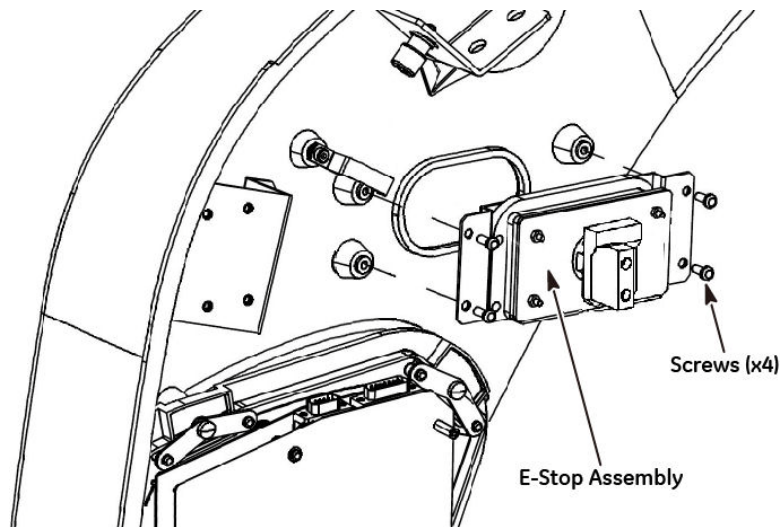

Figure 2-3 E-Stop Assembly Installation

- 5.) Route the cable assembly (5408663) along the inside edge of the rear cover, and temporarily fix the cable to the tie-wrap bases with tie-wraps.

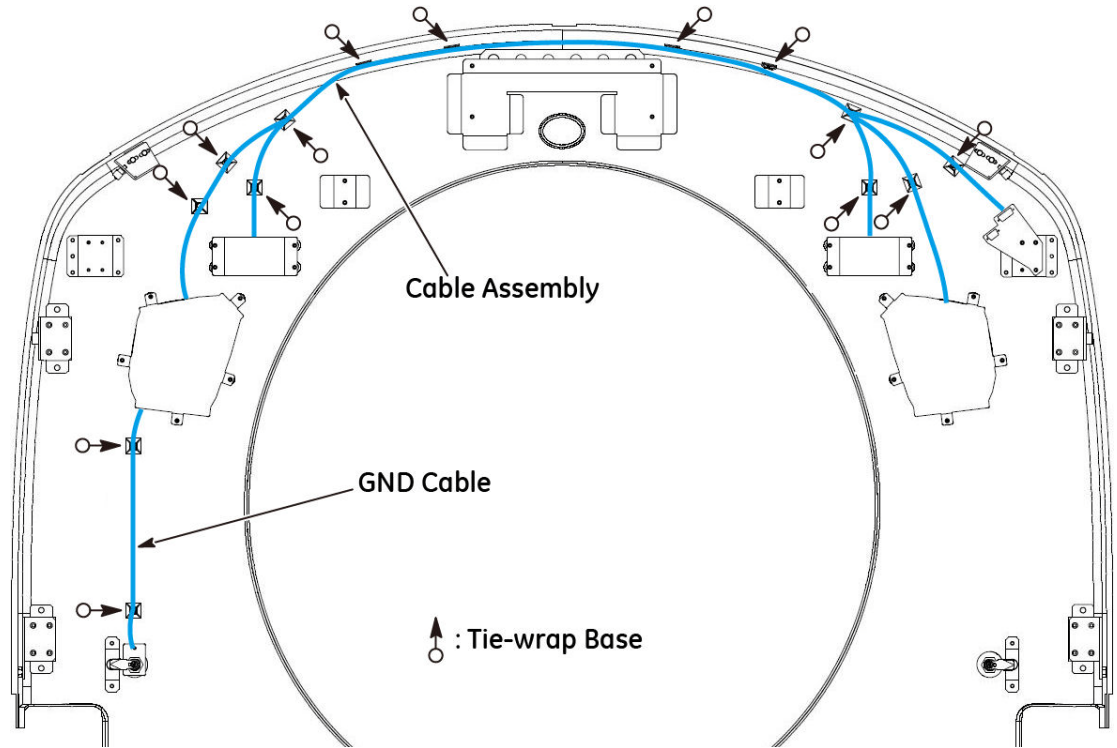

Figure 2-4 Cable Routing

- 6.) Connect cable connectors to the both control panels and e-stop buttons.

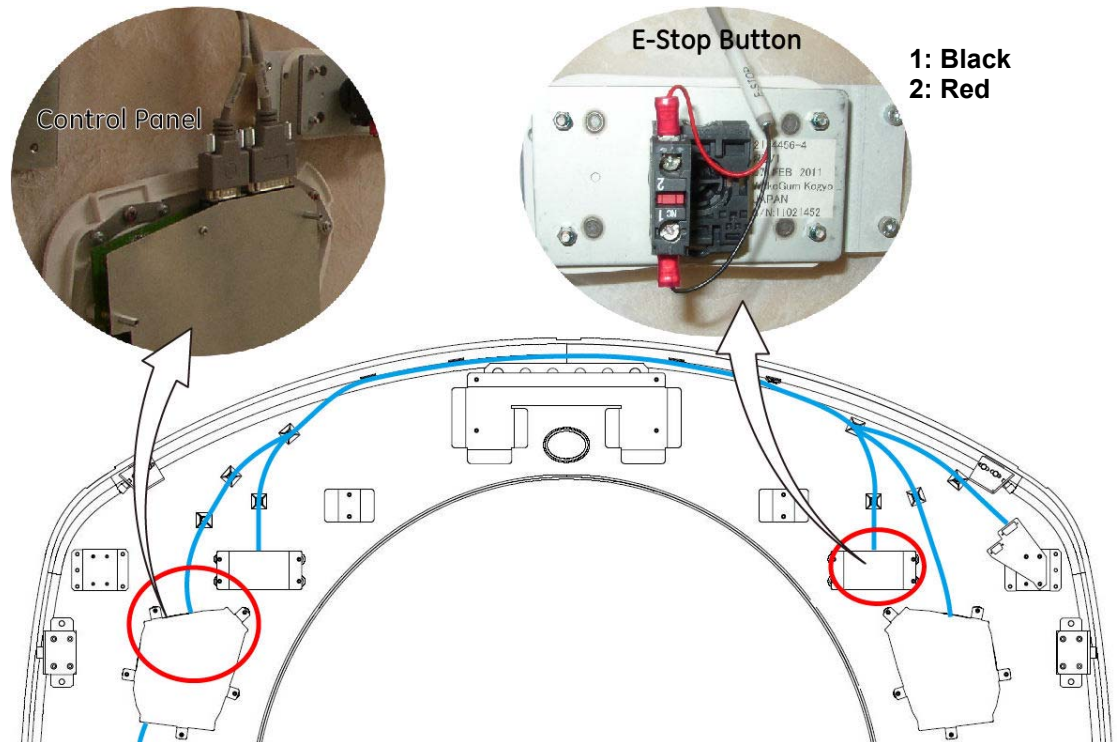

Figure 2-5 Cable Connections

- 7.) Attach two sub-board connectors to the sub-board bracket, and fix them with stud screws provided in this option kit (Washers are not necessary).

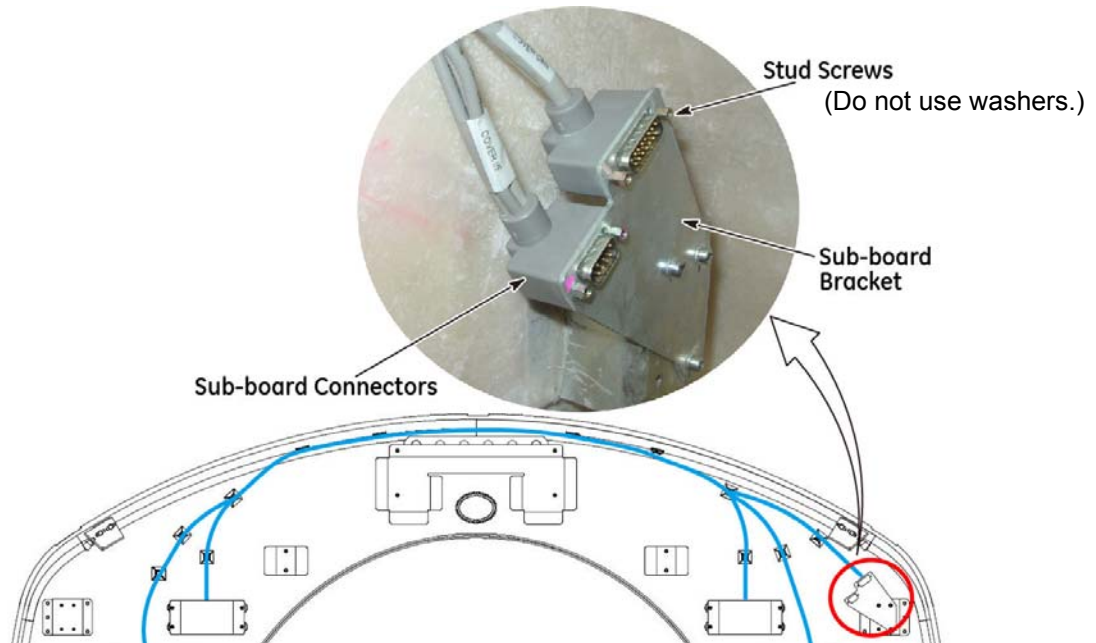

Figure 2-6 Sub-board Connectors

- 8.) Secure the cable assembly to the tie-wrap bases with tie-wraps.
- 9.) Connect the GND cable between the control panel (left) and a bracket on the rear cover, and secure the GND cable to the tie-wrap bases with tie-wraps.

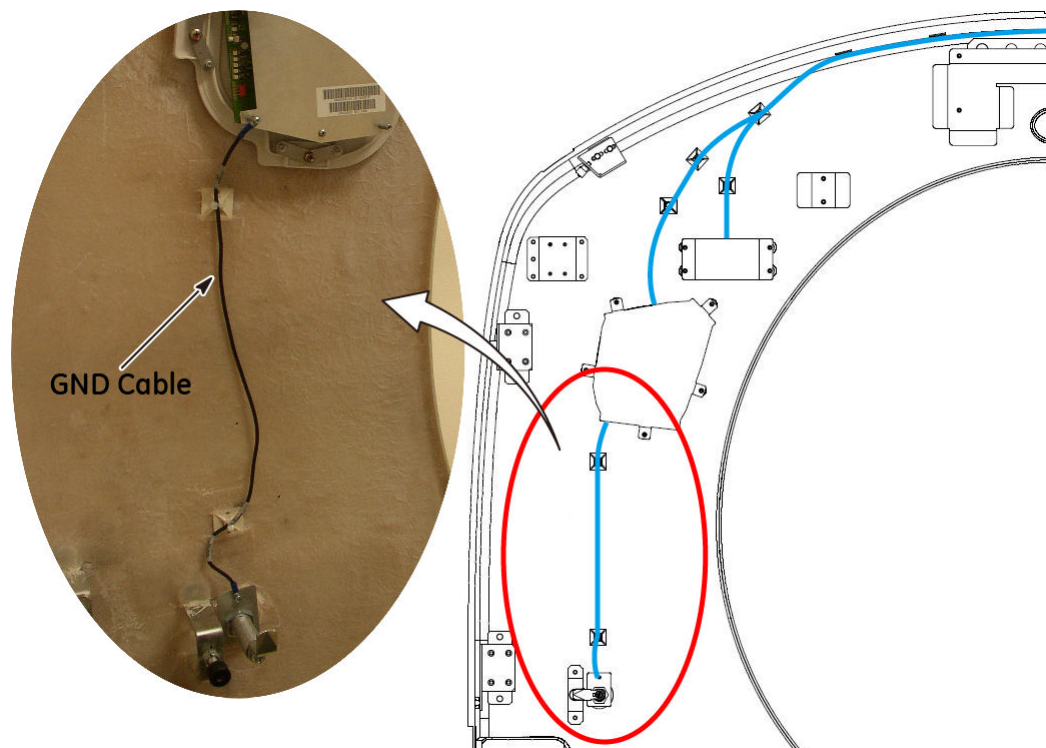

Figure 2-7 GND Cable Connection

- 10.) Install the cable assembly (5408660 and 5408662) as follows:
 - a.) Remove the cover of the PS_filter assembly.
 - b.) Disconnect RCVR BKHD J1 and REAR CVR J3 connectors.

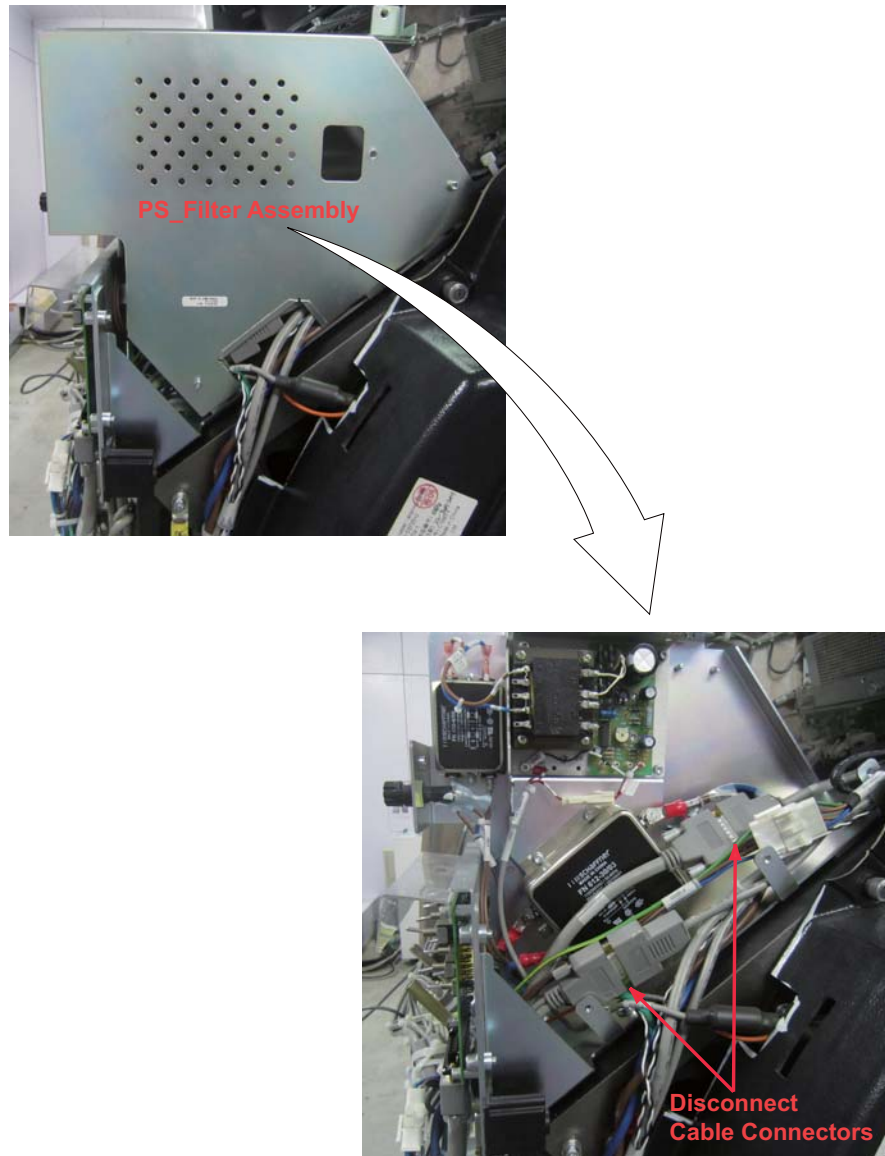

Figure 2-8 PS_Filter Assembly

c.) Connect the cable assemblies as shown in illustration.

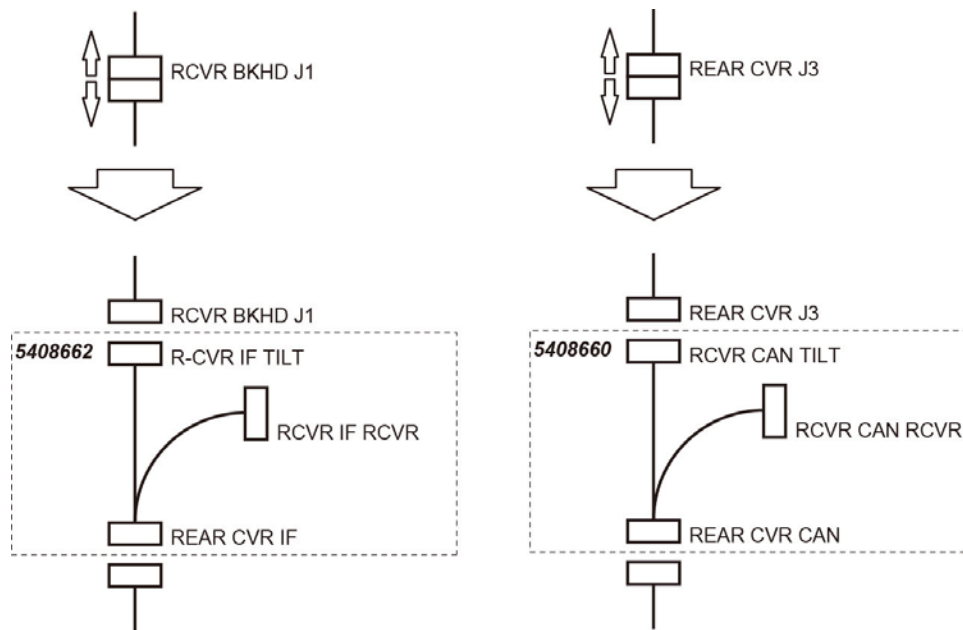

Figure 2-9 Cable Connections

d.) Re-install the cover.

- 11.) Re-install the rear cover to the rear slide unit.
- 12.) Remove the cover dolly.
- 13.) Connect two cable connectors to the sub-board connectors on the rear cover.
- 14.) Push the rear cover to gantry frame and secure the cover by turning two (2) latches.
- 15.) Restore power to the system.
- 16.) Check that the both sides of the control panel and e-stop button are operating normally.
- 17.) Turn off all 3 switches (Axial Drive, HVDC, 120VAC), and re-install the gantry covers.

Section 3.0 Finalization

3.1 Sanity Test

- 1.) Check that the both sides of Front/Rear control panels and e-stop buttons are operating normally.
- 2.) Execute some sanity scans and confirm that the system is working normally.

3.2 GIB Maintenance

Register locator card information to GIB database.

www.gehealthcare.com



Imagination at work