

OVER VIEW

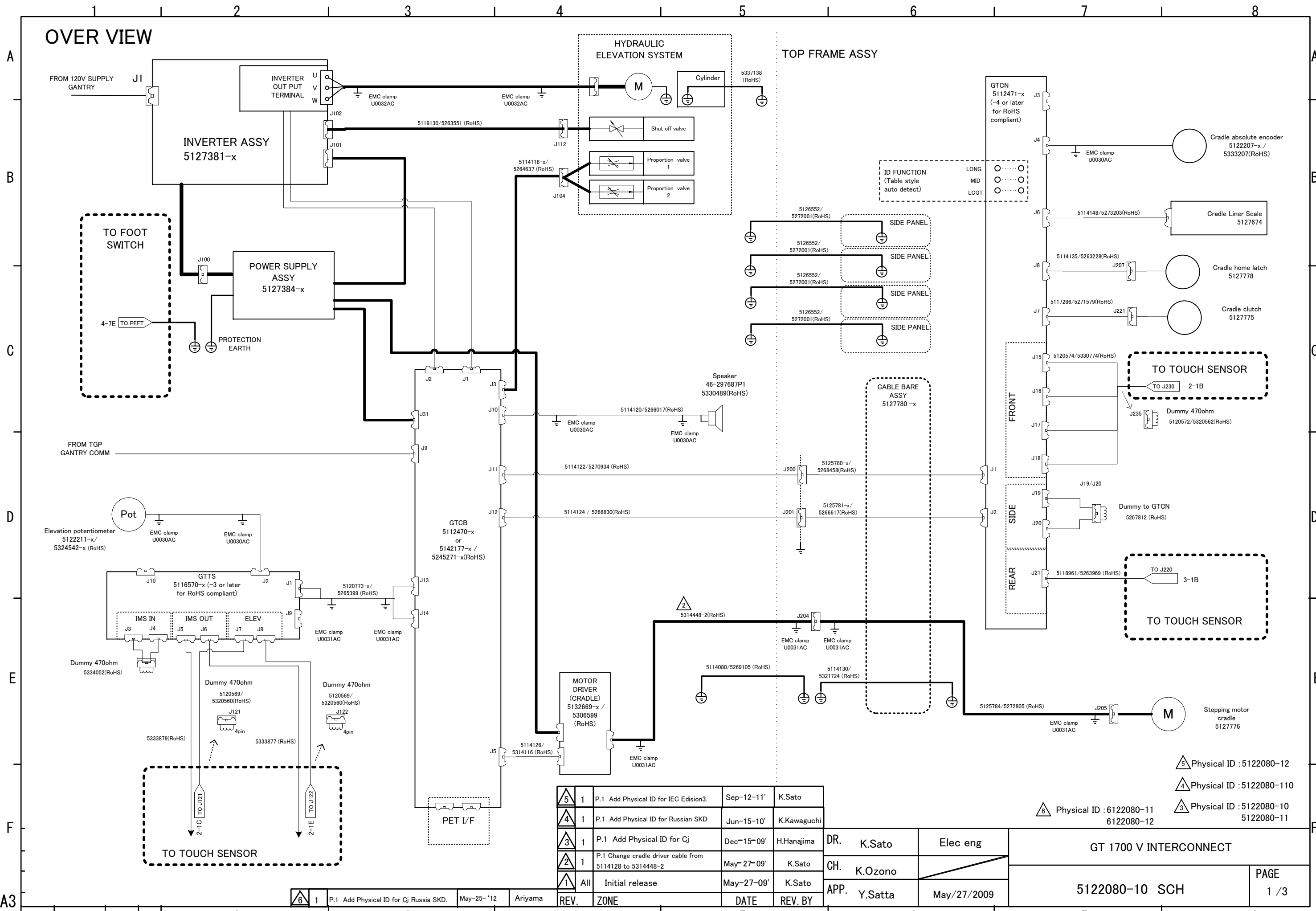

5	1	P.1 Add Physical ID for IEC Edision3.	Sep-12-11'	K.Sato
4	1	P.1 Add Physical ID for Russian SKD	Jun-15-10'	K.Kawaguchi
3	1	P.1 Add Physical ID for Cj	Dec-15-09'	H.Hanajima
2	1	P.1 Change cradle driver cable from 5114128 to 5314448-2	May-27-09'	K.Sato
1	All	Initial release	May-27-09'	K.Sato
REV.	ZONE	DATE	REV. BY	

DR.	K.Sato	Elec eng	GT 1700 V INTERCONNECT	PAGE 1 / 3
CH.	K.Ozono			
APP.	Y.Satta	May/27/2009		
			5122080-10 SCH	

SIZE A3
技術部

6	1	P.1 Add Physical ID for Cj Russia SKD.	May-25-11'	Ariyama
---	---	--	------------	---------

- 5 Physical ID : 5122080-12
- 4 Physical ID : 5122080-110
- 6 Physical ID : 6122080-11
6122080-12
- 3 Physical ID : 5122080-10
5122080-11

TOUCH SENSOR

TOP COVER FRONT ASSY 5127465 - x

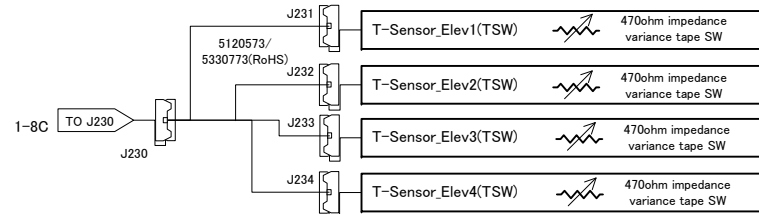

IMS LEFT SIDE COVER 5191722-10

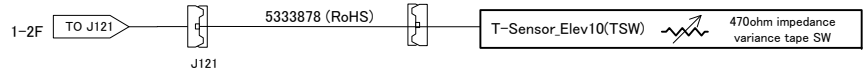

FRONT LEFT SIDE TS

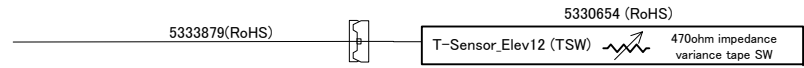

IMS RIGHT SIDE COVER 5191736-10

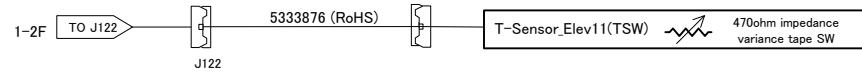

FRONT RIGHT SIDE TS

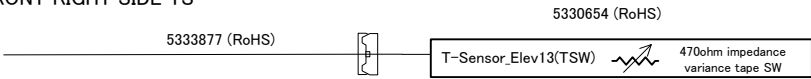

GT REAR TOUCH SWITCH 5125112

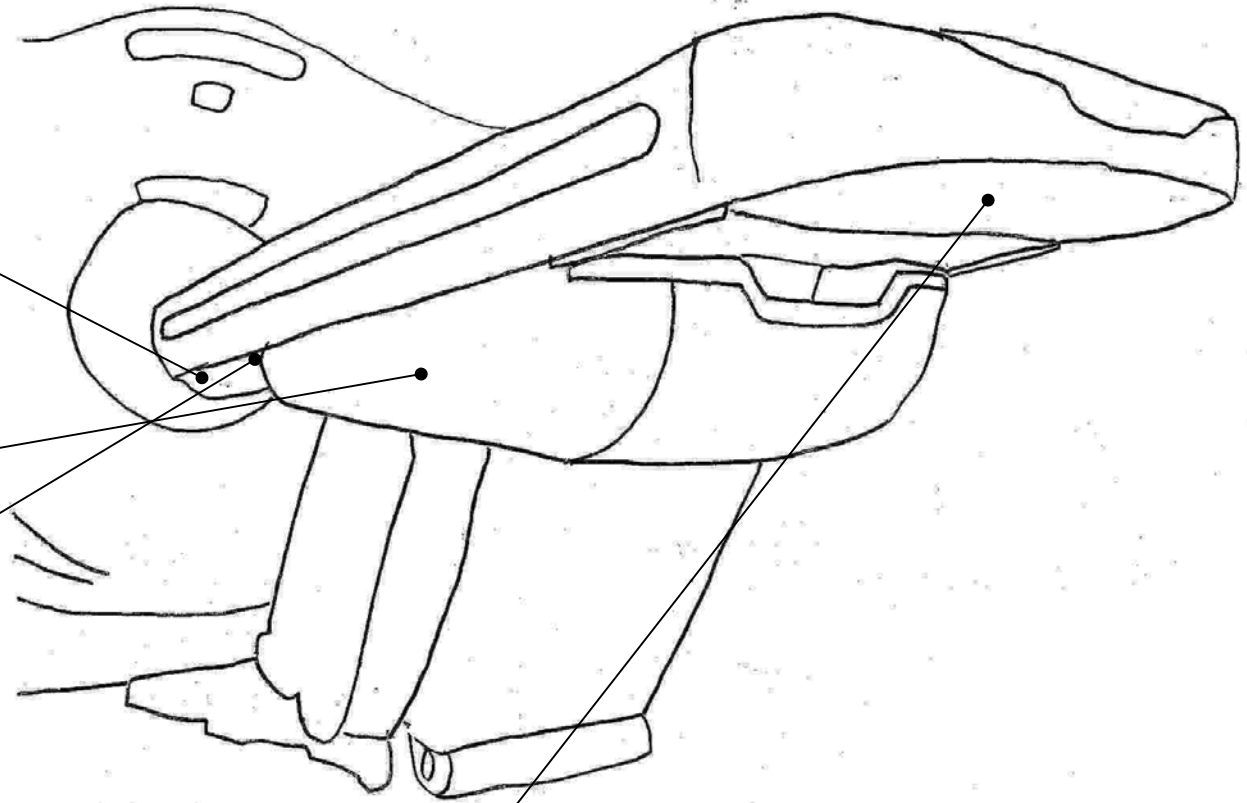
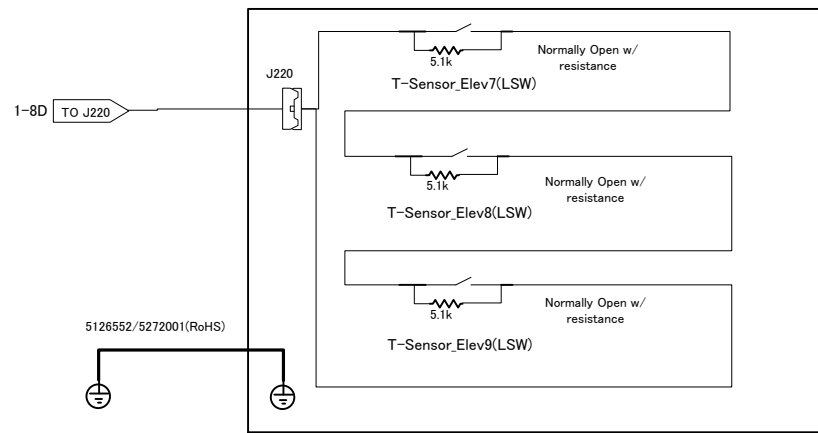

△		- -		DR.	K.Sato	Elec eng	GT 1700 V INTERCONNECT	
△		- -		CH.	K.Ozono		5122080-10 SCH	
△				APP.	Y.Satta	May/27/2009	PAGE	2/
REV.	ZONE	DATE	REV. BY					

SIZE A3

技術部

Form Y-13A-1

GE Healthcare

FOOT SWITCH

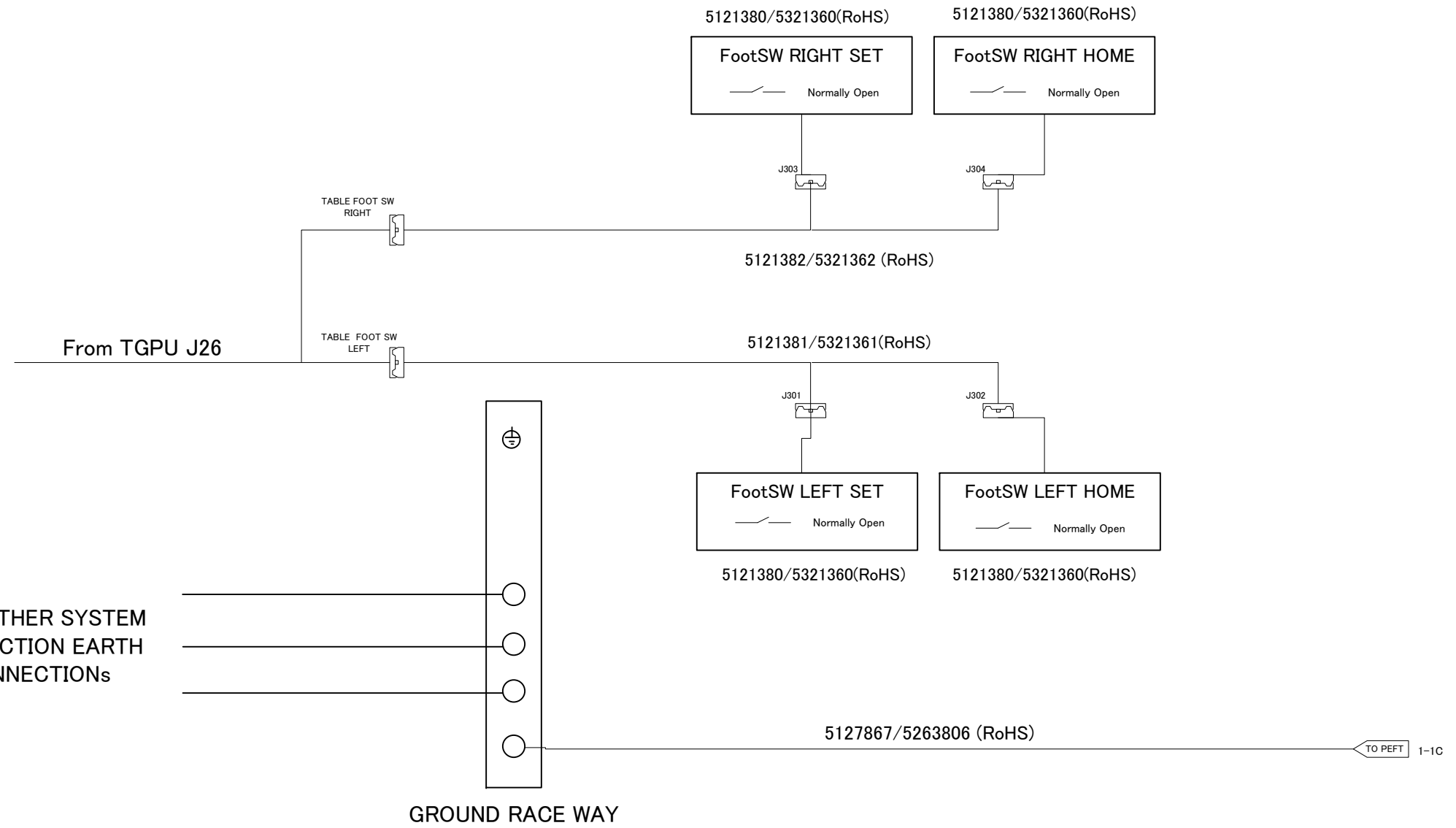

△		--		DR.	K.Sato	Elec eng	GT 1700 V INTERCONNECT	
△		--		CH.	K.Ozono		5122080-10 SCH	
△				APP.	Y.Satta	May/27/2009	PAGE 3/	
REV.	ZONE	DATE	REV. BY					

SIZE A3
技術部 MICRO - -